

Installation instructions

Transport | Installation | Operation | Maintenance | Disposal



Flat/Vertical COMPACT



Series: GCVC, GCHC, GFVC, GFHC, GGVC, GGHC

*These instructions are to be considered part of the unit.
Read and follow these instructions carefully before performing any work on the unit.
Always keep these instructions accessible in the immediate vicinity of the unit
for future reference.*

guntner.com/uk

About us

Product family and line:	Flat/Vertical COMPACT
Version number:	8
Date of revision:	2025-10-20

Copyright © 2026 by Güntner GmbH & Co. KG, Fürstfeldbruck, Germany.

This publication is protected by copyright.

All rights reserved. No part of this documentation may be copied, reproduced or transmitted into a form suitable for electronic systems and distributed in any form, even in part, without the authorisation of Güntner GmbH & Co. KG.

Installation instructions

These instructions have been compiled in several languages.

The German version applies as the **original installation instructions**. All other language versions are **translations** of the **original installation instructions**.

© Güntner GmbH & Co. KG
Hans-Güntner-Str. 2 – 6
82256 FÜRSTENFELDBRUCK

Phone +49 8141 242 0
Internet: www.guntner.com

Contents

1	Key basic information.....	7
1.1	Importance of the instructions.....	7
1.2	Applicable documents.....	7
1.3	Responsibilities.....	7
1.3.1	Responsibilities of the manufacturer of the system.....	7
1.3.2	Responsibilities of the owner or operator.....	8
1.4	Definition of the target group and requirements.....	8
1.5	Legal note.....	11
1.6	Document conventions.....	12
1.7	List of abbreviations.....	12
1.8	Conventions for safety signs and instructions.....	13
1.8.1	General safety signs and their meaning in these instructions.....	13
1.8.2	Warning signs and their meaning in these instructions.....	13
1.8.3	Prohibitory signs and their meaning in these instructions.....	14
1.8.4	Mandatory signs and their meaning in these instructions.....	15
2	Description.....	16
2.1	Types of Flat/Vertical COMPACT.....	16
2.1.1	Technical data of the unit.....	18
2.1.2	Technical data of the fans.....	20
2.2	General information.....	20
2.3	Design and function.....	21
2.3.1	Designs.....	21
2.3.2	Operating modes.....	22
2.4	Fan motor.....	23
3	Safety.....	25
3.1	Intended/improper use.....	25
3.1.1	Intended use.....	25
3.1.2	Operating conditions.....	25
3.1.3	Improper use.....	25
3.2	Labelling on the packaging/the unit.....	26
3.2.1	Packaging overview.....	26
3.2.2	Signs and notes on the packaging.....	27
3.2.3	Unit overview.....	30
3.2.4	Safety signs on the unit.....	33
3.2.5	Other signs and notes on the unit.....	35
3.3	Basic safety instructions.....	35

3.3.1	Please note.....	35
3.3.2	Electrical hazard.....	36
3.3.3	Hazard due to working fluids.....	36
3.3.4	Hazard due to vibrations.....	38
3.3.5	Hazard due to pressurised parts.....	39
3.3.6	Thermal hazard.....	40
3.3.7	Mechanical hazard.....	40
3.3.8	Hazard due to fans.....	42
3.3.9	Other hazards.....	43
4	Transport and unpacking.....	44
4.1	Safety instructions for transport and unpacking.....	44
4.2	Transport and storage of the unit.....	45
4.2.1	Transporting the unit.....	45
4.2.2	Storing the unit prior to installation.....	46
4.3	Unpacking the unit.....	46
4.4	Checking the transport pressure.....	49
5	Installation and commissioning.....	51
5.1	Safety instructions for installation and commissioning.....	51
5.2	Requirements for the place of installation.....	52
5.3	Installation of the unit.....	56
5.3.1	Mounting the legs.....	56
5.3.2	Mounting the vibration dampers (accessories).....	59
5.3.3	Mounting the unit.....	60
5.4	Connecting the unit.....	62
5.4.1	Connecting the unit to the plant.....	62
5.5	Electrically connecting and protecting the unit.....	64
5.6	Connection diagrams.....	65
5.7	Performing an acceptance test.....	65
6	Operation.....	68
6.1	Safety instructions for operation.....	68
6.2	Putting the unit into operation.....	68
6.3	Taking the unit out of operation.....	69
6.4	Shutting down the unit.....	70
6.5	Putting the unit back into operation after shutdown.....	70
6.6	Changeover to a different working fluid.....	71
6.7	Troubleshooting.....	71
7	Maintenance and cleaning.....	74
7.1	Safety instructions for maintenance and cleaning.....	74
7.2	Procedure prior to all maintenance work.....	75
7.3	Inspection/maintenance schedule.....	76

7.3.1	Unit.....	76
7.3.2	Heat exchanger coil.....	77
7.3.3	Fans.....	77
7.4	Maintenance work.....	78
7.4.1	Fixing leaks.....	78
7.4.2	Cleaning the unit.....	78
7.4.3	Cleaning the coil.....	79
7.4.4	Cleaning the fans.....	80
7.5	Procedure after all maintenance work.....	81
8	Dismantling and disposal.....	82
8.1	Safety instructions on dismantling and disposal.....	82
8.2	Dismantling the unit.....	83
8.3	Disposing of the unit.....	83

Version history

The following table lists the respective changes compared to the old versions.

Attention! Minor changes to the instructions, such as the wording of the text or the layout, are not listed separately.

Version of the instructions	Changes/additions
6	Version of the instructions after which the version history was introduced
7	The following changes have been made to these instructions: <ul style="list-style-type: none">• Revision of the structure and outline of the manual• Update of the standards for fans, additional text regarding EC fans• New tag on the packaging: 64551.1 – Note on cable anchoring
8	The following has been adapted in these instructions: <ul style="list-style-type: none">• Revision of the structure• Addition of important notes on preventing damage to the cooling circuit when water/glycol is used as the working fluid• Minor additions/changes and corrections

1 Key basic information

1.1 Importance of the instructions

These instructions apply for the units of the Flat/Vertical COMPACT product family and line. The Flat/Vertical COMPACT is a unit for heat dissipation for outdoor installation. The Flat/Vertical COMPACT offers the possibility of operation with various working fluids and different operating principles (e.g. FC/HFC: condenser; water/glycol: fluid cooler; CO₂: gas cooler). In addition, a variety of casings, variable equipment options, manifold combinations of materials and adjusted fan concepts are available.

Legal framework

These instructions have been written for the European Union.

The following directives and standards apply under EU law:

- Machinery Directive 2006/42/EC
- Pressure Equipment Directive 2014/68/EU ¹⁾
- EMC Directive 2014/30/EU

¹⁾ Not all products fall within the scope of this Directive

1.2 Applicable documents

The following documents are applicable:

- These instructions
- Connection diagram (enclosed with the terminal box)
- For further technical data, see nameplate

These instructions are part of the system's operating instructions, which are provided by the system's manufacturer.

1.3 Responsibilities

1.3.1 Responsibilities of the manufacturer of the system

The responsibilities of the manufacturer of the system are reflected in the unit's construction in acc. with EN 378-2 (design, manufacture and testing).

The manufacturer of the system has the following obligations:

- Planning, design and calculation of the system in acc. with the statutory provisions, possibly also by an external planning consultancy (for required qualifications, see "Definition of the target group and requirements").
- Creation of the technical documentation and the system's operating instructions.
- Performing the conformity assessment procedure(s) and creation of the declaration(s) of conformity.

- Planning and preparing emergency measures:
To avoid consequential damage caused by malfunction, a warning system that immediately signals all faults must be provided on site. Prepare emergency measures that prevent consequential damage to persons, property and the environment should faults occur.
- Specify checking and maintenance intervals:
The system must be designed and equipped with all required equipment for maintenance, servicing and testing in acc. with EN 378-4.
- Point out the need for sufficient instruction of the operating and monitoring personnel for the operation and maintenance of the system.
- Inform Güntner GmbH & Co. KG (component supplier) immediately if faults occur during the installation, startup and operation:
claims@guentner.com

When the unit is integrated into the refrigeration system, the working fluid and unit type must not deviate from the order-related information specified in the order documents.

It is recommended that the future customer staff – if possible – is present on site during the installation, for tightness tests and cleaning, while the system is being filled with working fluid and for the adjustment of the system.

The accident prevention rules and regulations that apply for the place of installation must also be observed.

1.3.2 Responsibilities of the owner or operator

The responsibilities of the owner or operator are reflected in the operation, maintenance, repair and recovery of the system in acc. with EN 378-4.

The owner or operator must ensure that the employees entrusted with the operation, monitoring and maintenance of the system are adequately instructed and competent.

The operating personnel responsible for the system must have sufficient knowledge and experience with regard to the operating principles, operation and daily monitoring of this system.

Before commissioning the system, the owner or operator must ensure that the operating personnel are sufficiently instructed about the system's documentation (which is part of these instructions) on the set-up, monitoring, operating principles and maintenance of the system and the safety measures to be observed, and with regard to the properties and handling of the working fluid to be used.

The owner or operator must ensure that when operating, monitoring and maintaining the system, the working fluid and unit type do not deviate from the information specified in the order documents.

Planning and preparing emergency measures: To avoid consequential damage caused by malfunction, a warning system that immediately signals all faults must be provided on site. Prepare emergency measures that prevent consequential damage to persons, property and the environment should faults occur.

Responsibility remains with the owner or operator of the system if the system is used by anybody else unless there is an agreement on a different division of responsibilities.

1.4 Definition of the target group and requirements

General

Only persons who meet the requirements for the personnel may work in the area of the unit. This group of persons is defined below. To prevent damage to health and property, the operator must take measures to prevent unauthorised persons from gaining access to the unit.

Persons who are responsible for working on this unit in the various phases of its life cycle must have the necessary qualifications and competence for the respective tasks in acc. with the applicable local regulations.

Definition of the group of persons

Person	Qualification
Consultant for technical building equipment (TBE)	Master's or Bachelor's degree, or similar educational background, in the field of plant construction, supply engineering or refrigeration and air conditioning
Lorry driver	Valid LGV licence, additional training for heavy loads if necessary
Crane/forklift operator	Valid driving licence for crane/forklift truck
Warehouse worker	Specialised training as a warehouse worker or at least sufficient in-house qualification
Skilled electrician	Qualified training to become a (skilled) electrician
Fitter/welder	Qualified training for the installation and welding of pipes and the installation of cooling circuits and refrigeration plants
Skilled welder	Qualified training to become a welder for coolant and refrigerant pipes that are subject to approval due to their classification in acc. with the Pressure Equipment Directive
Refrigeration technician	Training to become a recognised mechatronics technician for refrigeration and air conditioning technology (master craftsman), or refrigeration engineer (Bachelor's degree). If necessary, additional training for handling flammable or toxic refrigerants such as propane or NH ₃
Mechanic	Training to become an industrial mechanic or comparable specialised training
Operator	Is able to monitor the safe operation of the system
Cleaning professional	Instruction in the use of cleaning methods and suitable cleaning agents

Definition of tasks for the respective life cycle phases

Life cycle phase	Task	Group of persons
Transport and storage	Transporting to the storage location or place of installation	Lorry driver
	Loading/unloading	Crane/forklift operator, warehouse worker
	Performing incoming goods inspection	Warehouse worker
	Performing intermediate storage	Crane/forklift operator, warehouse worker
Unpacking	Unpacking	Mechanic, warehouse worker
	Checking the transport pressure	Fitter/welder, refrigeration technician
	Performing maintenance runs of fans	Skilled electrician
	Disposing of packaging material	Warehouse worker
Mounting/installation	Loading/unloading at the place of installation	Crane/forklift operator
	Mounting/installing and removing	Fitter/welder, refrigeration technician, mechanic
Connection	Connecting electrical components	Skilled electrician, refrigeration technician
	Connecting hydraulic/refrigeration components	Fitter/welder, refrigeration technician
	Welding/brazing refrigerant pipes	Skilled welder
	Flushing the pipes	Fitter/welder, refrigeration technician
	Performing acceptance tests	Fitter/welder, refrigeration technician
Commissioning	Filling with working fluid	Fitter/welder, refrigeration technician
	Performing the commissioning and settings	Fitter/welder, refrigeration technician
Operation	Performing functional checks	Operator
	Switching on/off	Operator
	Monitoring the cooling operation	Fitter/welder, refrigeration technician, operator
	Checking for damage	Skilled electrician, fitter/welder, refrigeration technician, operator
Troubleshooting	Performing a visual inspection	Skilled electrician, fitter/welder, refrigeration technician, mechanic, operator, cleaning professional
	Performing refrigeration tests	Refrigeration technician
	Performing electrical tests	Skilled electrician, refrigeration technician

Life cycle phase	Task	Group of persons
Maintenance/repair	Performing a visual inspection	Operator
	Replacing wear parts	Skilled electrician, fitter/welder, refrigeration technician, mechanic
	Performing weekly maintenance	Operator
	Performing annual maintenance	Skilled electrician, fitter/welder, refrigeration technician, mechanic
	Replacing fans	Skilled electrician, refrigeration technician, mechanic
	Replacing the control system	Skilled electrician, refrigeration technician
	Fixing leaks	Fitter/welder, refrigeration technician, skilled welder
	Performing cleaning tasks	Fitter/welder, refrigeration technician, cleaning professional
Shutdown and taking out of operation	Taking out of operation	Fitter/welder, refrigeration technician
	Shutting down	Fitter/welder, refrigeration technician
	Draining/removing by suction (refrigerant)	Refrigeration technician
	Draining (water)	Fitter/welder
Removal	Disconnecting the lines	Skilled electrician, refrigeration technician
	Disassembling/dismantling/removing	Fitter/welder, refrigeration technician, mechanic
Disposal	Disposing of materials	Crane/forklift operator and lorry driver, refrigeration technician, operator

1.5 Legal note

Note that warranty claims require the existence of a defect that must be proved. These installation instructions are part of the unit and must be observed in their entirety. Damage and malfunctions resulting from the failure to comply with the installation instructions are not covered by the warranty. This applies in particular to the use of spare parts other than those specified (original spare parts in case of doubt) and modifications to the unit compared to its original condition on delivery without the consent of Güntner GmbH & Co. KG. Modifications in this sense are, in particular, the use of working fluids other than those specified, changes to the operating parameters and mechanical changes such as metal-cutting operations (e.g. drilling) without sufficient protection of the unit against chips.

1.6 Document conventions

Mark-up elements for special information



bold	Requires special attention!
⇒ –	Instructions Instructions (sub-item)
• ◦	Listing Listing (sub-item)

1.7 List of abbreviations





Abbreviation	Meaning
°C	Degrees Celsius (Celsius scale temperature)
1~	Single-phase alternating current
3~	Three-phase current
bar	Bar (pressure indication)
BImSchV	German Federal Emission Control Regulation
CO ₂	Carbon dioxide working fluid
D	Delta connection (electrical connection type with three-phase motors)
PED	Pressure Equipment Directive
EN	European standard
EN 378	European standard 378: Refrigeration systems and heat pumps; safety-related and environmental requirements
HFC/FC	(Hydro)fluorocarbons working fluid
Hz	Hertz (frequency)
IP	Degree of protection against the penetration of solids/liquids
ISO	International Organization for Standardization (German: Internationale Organisation für Normung)
l	Litre (volume)
mm	Millimetre
NH ₃	Ammonia working fluid
Emergency STOP	Switch for immediately switching off the refrigeration system
PPE	Personal protective equipment
S	Star connection (electrical connection type with three-phase motors)
VDE	“Verband der Elektrotechnik Elektronik Informationstechnik e. V.” (Association for Electrical, Electronic and Information Technologies)

1.8 Conventions for safety signs and instructions

1.8.1 General safety signs and their meaning in these instructions

⚠ DANGER	
	This signal word is used to show an immediately dangerous situation which, if not avoided, will cause severe injury or death.
⚠ WARNING	
	This signal word is used to show a potentially dangerous situation which, if not avoided, could cause severe injury or death.
⚠ CAUTION	
	This signal word is used to show a potentially dangerous situation which, if not avoided, could cause minor or moderate injury.
ATTENTION	
This signal word without any safety symbols is used to show a possible risk of damage to property.	
NOTICE	
This signal word indicates additional information that is useful for the reader, such as operator tips and cross references.	

1.8.2 Warning signs and their meaning in these instructions

	Warning of hand injury Failure to observe the warnings can result in hands or fingers being crushed, drawn in or otherwise injured.		Warning of hot surface The temperature is above +45 °C (the temperature at which protein clots) and can cause burns.
	Warning of extreme cold The temperature is below 0 °C and can cause frostbite.		Warning of dangerous electrical voltage Risk of an electric shock if live parts are touched.



Warning of heavy loads
Severe injuries can occur when lifting.



Warning of the risk of cutting
Sharp edges and corners.



Warning of risk of crushing
Transport, loading and unloading can result in life-threatening injury.



Warning of the risk of tripping
When entering this area, there is a risk of tripping over obstacles or uneven surfaces.



Warning of the risk of falling
Risk of falling when working high up.



Warning of the the risk of slipping
After defrosting, after cleaning work or due to other circumstances, there is a risk of slipping.



Warning of explosive substances at the place of installation
Use of ignition sources can cause explosions at the place of installation.



Warning of flammable substances at the place of installation
Use of ignition sources can cause fire at the place of installation.



Warning of toxic substances at the place of installation
Contact with or inhaling toxic substances can cause injury or death.



Warning of suspended loads
Standing under suspended loads can cause injury or death.



Warning of risk of suffocation
Being in an atmosphere with oxygen deficiency or with hazardous substances, gases or vapours can cause suffocation and death.



Warning of high operating pressure
Breakage of pressurised components can cause injury or death.



Warning about general risks
General hazards to persons can cause injury or death.



Warning of automatic start-up
Automatic start-up of fans can result in hands and fingers being trapped.



Warning of the danger of pulling in
If body parts are being pulled in to the unit, this can cause injury or death.



Warning of corrosive substances
Contact with corrosive substances can cause injuries, especially to the eyes.

1.8.3 Prohibitory signs and their meaning in these instructions



No fire, no naked flames and no smoking!
Ignition sources must be kept away or at a safe distance, and ignition sources must not develop.



No climbing!
Do not climb onto the unit and do not place heavy loads on the unit.



No lifting!
Do not lift the unit at this area, and do not attach lifting gear at this area.



Do not enter!
Do not enter the marked area.

1.8.4 Mandatory signs and their meaning in these instructions



Use hearing protection!
Hearing protection must protect against loud noises.



Wear protective clothing!
Personal protective clothing must be suitable for the working fluid used and for low temperatures respectively, and must have good heat insulation properties.



Completely disconnect before working!
Completely disconnect the electrical system and secure it against restart before performing installation, maintenance and repair work.



Use eye protection!
Eye protection must protect against mechanical and chemical dangers and radiation.



Wear protective headgear!
Head protection must protect against hazards caused by impact with objects, swinging objects, falling objects or ejected objects.



Wear safety shoes!
Safety shoes must protect against external, damaging influences and offer protection against slipping.



Wear protective gloves!
Protective gloves must protect against mechanical and chemical dangers.



Observe these instructions!
Read and follow these instructions carefully.



Use respiratory protection!
Breathing apparatuses must be suitable for the working fluid used. Breathing apparatuses must consist of:

- At least two self-contained breathing apparatuses (respiratory protective devices)
- For ammonia: an additional breathing apparatus with filter (full mask) or a self-contained breathing apparatus (respiratory protective device)



Lifting point/lifting hook
Marking of lifting points to ensure safe transport of loads.

2 Description

2.1 Types of Flat/Vertical COMPACT

Introduction

Güntner's Flat/Vertical COMPACT is a heat exchanger with variable equipment. Depending on the requirements, it can be configured in the most diverse variants. The following tables show the individual configuration options available for the Flat/Vertical COMPACT.

Refer to the order documents for the exact unit name.

Letter (example)	Meaning	Possible variants
G	Company	G: G üntner
C	Operation	C: C ondenser F: F luid cooler G: G as cooler O: O il cooler S: S ubcooler
H	Design	H: H orizontal V: V ertical D: D iagonal
V	Product line	C: C OMPACT V: V ARIO I: I ndoor [APPLICATION]
R	Fluid	A: A mmonia R: R efrigerants (A1 refrigerants) C: C O ₂ P: P otentially dangerous (refrigerants of class A2L and higher) F: F luids in general O: O il W: W ater (water operation only)
D	Operating mode	D: D ry (without humidification of supply air or fins) P: Adiabatic pad pre-cooling system hydroBLU™ (P ad) S: hydro S PRAY™ spray system H: H ybrid (direct humidification of fins)

Exemplary presentation of the nomenclature

NOTICE

If not marked separately, all information in the following sections refer to the standard unit!

Fans

Module	Number of fans	Fan diameters
A	1 – 2	350 mm, 400 mm
B	1 – 3	350 mm, 400 mm, 450 mm, 500 mm
C	1 – 8	450 mm, 500 mm, 630 mm
D	1 – 6	500 mm, 630 mm, 800 mm

Available working fluids and their operating modes

Working fluid	Operating mode
FCs/HFCs of class A1	Dry
CO ₂	Dry
Refrigerants of classes A2L to A3	Dry
Heat carriers (e.g. water/glycol)	Dry
Ammonia (NH ₃)	Dry

Material combinations available as a standard

Material	Core tube	Fin	Casing	Header outlet/header inlet	Connections
Aluminium		X			
Copper	X*			X	X*
High-strength Cu alloy	X**				X**
Aluminium, epoxy resin-coated		(X)			
Galvanised steel, powder-coated			X		
Stainless steel V2A/AISI 304	X***		(X)	(X), X**, X***	(X)**, X***

- X Standard design
- (X) Optional
- * Standard design (all working fluids except CO₂ and NH₃)
- ** CO₂
- *** NH₃

Time limits

Service life: 10 – 12 years

Accessories available as a standard

- External subcooler
- Vibration dampers
- Additional leg heights: 600 mm, 800 mm, 1000 mm
- Shortened legs

2.1.1 Technical data of the unit

NOTICE

The specified typical values refer to standard types of this series. The following applies to special units in particular: Observe the specifications in the design (appendix) and on the nameplate.

NOTICE

The capacity values of the fans depend on the ambient temperature and the air resistance at the place of installation.
All electrical parts are designed in accordance with EN standards.

Series and suffix	GCHC/GCVC AD	GCHC/GCVC PD	GCHC/GCVC RD
Project number	See nameplate		
Unit name	See nameplate		
Serial number	See nameplate		
Year of manufacture	See nameplate		
Working fluid	NH ₃	Refrigerants of classes A2L to A3	FCs/HFCs of class A1
Volume	See nameplate		
Max. permissible pressure (PS)	32 bar	32 bar	32 bar
Max. permissible temperature (TS)	-50/+150 °C	-50/+100 °C	-50/+100 °C
Permissible humidity	0 – 100 %	0 – 100 %	0 – 100 %
Airborne noise emitted	See order documents		
Weight	See order documents		

Series and suffix	GFHC/GFVC FD/WD
Project number	See nameplate
Unit name	See nameplate
Serial number	See nameplate
Year of manufacture	See nameplate
Working fluid	Water/glycol; water
Volume	See nameplate
Max. permissible pressure (PS)	0 – 10 bar

Series and suffix	GFHC/GFVC FD/WD
Max. permissible temperature (TS)	-50/+100 °C
Permissible humidity	0 – 100 %
Airborne noise emitted	See order documents
Weight	See order documents

Series and suffix	GGHC/GGVC CD
Project number	See nameplate
Unit name	See nameplate
Serial number	See nameplate
Year of manufacture	See nameplate
Working fluid	CO ₂
Volume	See nameplate
Max. permissible pressure (PS)	0 – 120 bar / -1 bar
Max. permissible temperature (TS)	-50/+150 °C
Permissible humidity	0 – 100 %
Airborne noise emitted	See order documents
Weight	See order documents

Legally binding values are indicated on the nameplate.

2.1.2 Technical data of the fans

For the GCVC, GCHC, GFVC, GFHC, GGVC, GGHC series, fans with a diameter of 350 to 800 mm are used. Fans with diameters up to 500 mm are operated with AC, fans larger than 500 mm in diameter are operated in DC. Güntner control devices can be used to control fan speeds (optional).

Fan type	See order documents
Degree of protection	At least IP44, thermal class 155 (F) and EN 60034-1
Voltage	400 V 3~ 50 Hz or 230 V 1~ 50 Hz
Balancing quality	Q 6.3 in acc. with DIN ISO 21940-11
Permissible ambient temperature	Temperature range: At least -30 °C to +55 °C
Protective devices	<ul style="list-style-type: none"> • Thermal: thermal contacts (NC) • Mechanical: Protection guard in acc. with EN 13857

2.2 General information

Introduction

Units of the Flat/Vertical COMPACT product family and line are intended for installation in a refrigerating plant (condensers/gas coolers) and in the heat carrier circuit of a cooling plant respectively (dry coolers). The refrigerating plant/cooling plant is a combination of interconnected refrigerant-carrying components and fittings that form a closed circuit in which the working fluid circulates.

Overview

The design and function are shown using the example of a standard unit of the Flat/Vertical COMPACT.

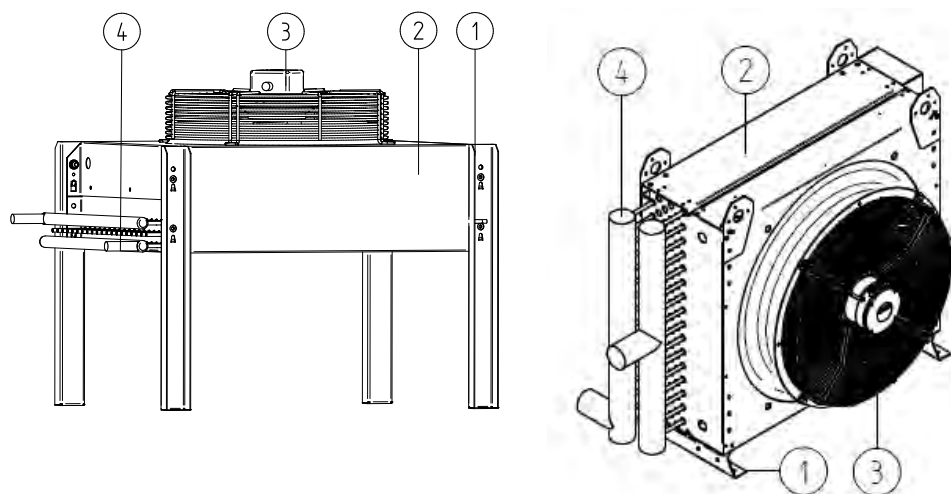

Operation

No.	Designation	Operation
1	Legs for floor mounting/base frame	Support the unit
2	Casing	Protection for coil and fins
3	Fan	Dissipation of heat released by the working fluid into the atmosphere
4	Unit connections	Connection of the pipes to the refrigerating plant

2.3 Design and function

2.3.1 Designs

Overview

The unit is available with up to eight fans. The following figures are schematic representations of possible designs for Flat and Vertical.

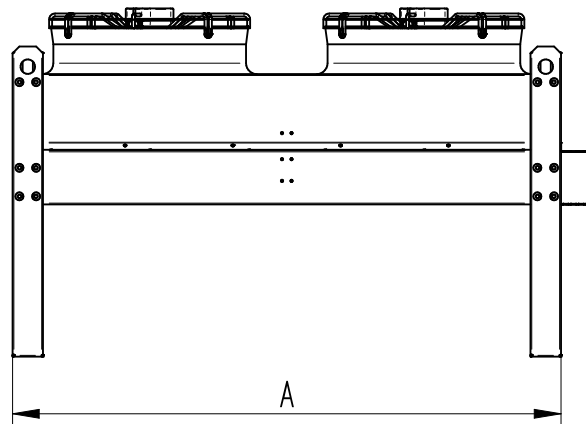

Example: GCHC module A with 2 fans (finoox)

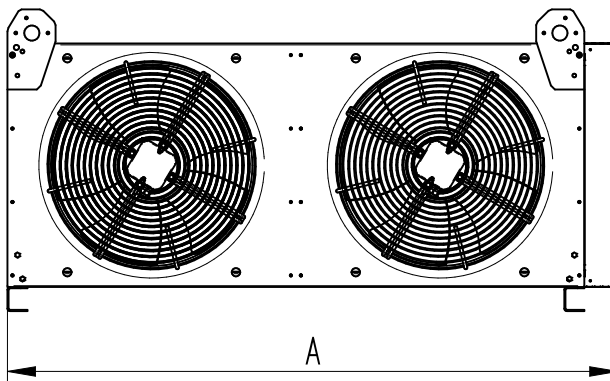
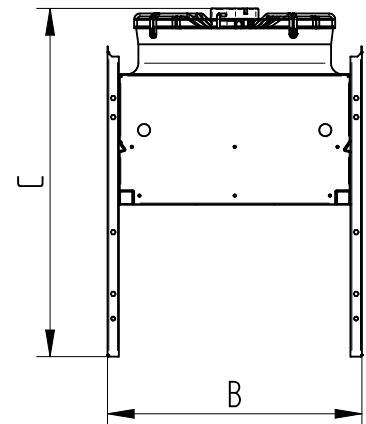

Example: GCVC module B with 2 fans (finoox)

- A: Unit length
- B: Unit width
- C: Unit height

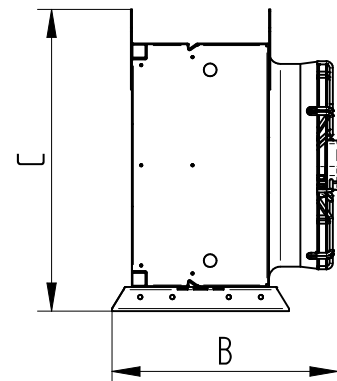

Refer to the order documents for the dimensioning of the units for the available sizes.

2.3.2 Operating modes

Introduction

The unit can be operated in one way:

- **Dry**

Dry operation

The heat exchanger coil is dry. The ambient air is taken in by the fans, then heated up while passing through the heat exchanger coil and finally discharged.

GFHC and GFVC dry coolers (on the left) and GCHC and GCVC condensers/GGHC and GGVC gas coolers (on the right)

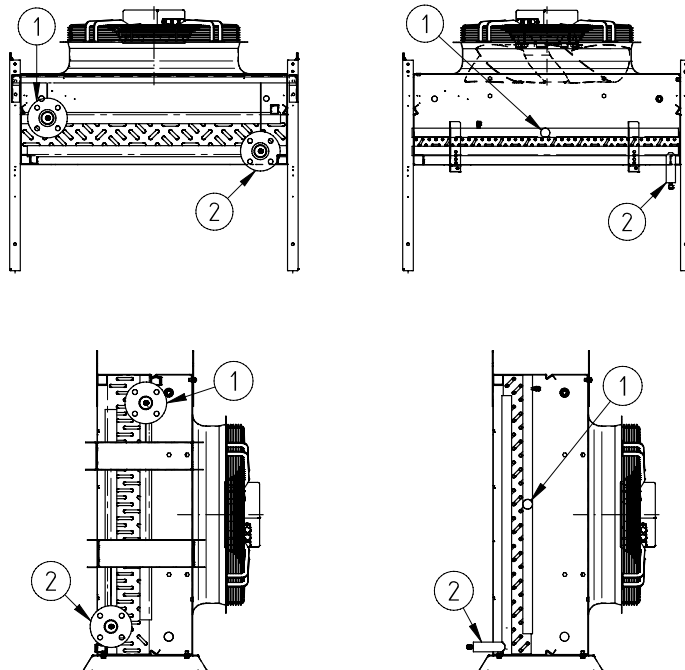

No.	GFHC and GFVC dry coolers	GCHC and GCVC condensers/GGHC and GGVC gas coolers
1	Inlet of coolant	Inlet of refrigerant
2	Outlet of coolant	Outlet of refrigerant

Operating principle

With FC/HFC, NH₃, CO₂ and propane:

Condensers liquefy the evaporated refrigerant by dissipating heat to the air that is guided over the heat transfer surface by the fans.

With gas coolers (CO₂), there are two different operating modes. In transcritical operation, the unit acts as a gas cooler and in subcritical operation as condenser.

In transcritical operation, the incoming gaseous CO₂ is cooled by dissipating heat into the ambient air. There is no change of state.

In subcritical operation, the incoming gaseous CO₂ is cooled, liquefied and subcooled by dissipating heat into the ambient air.

With the water/glycol working fluid:

Dry coolers (fluid coolers) cool the heat carrier by dissipating heat to the air (air side) that is guided over the heat transfer surface by the fans. There is no change of state.

2.4 Fan motor

Safety

NOTICE

Operate the unit once a month at full speed for at least three hours so that the bearings move and any penetrated condensate can evaporate.

NOTICE

With fans with an IP rating or higher, open the existing closed condensation water holes at least once a month.

AC technology

The AC motors are usually protected from superheating by a thermal contact (or PTC resistor).

With motors with thermal contact, wire the thermal contact in such a way that the motor cannot be started when the thermal contact is triggered. A locking device is recommended to prevent unintentional restart.

Motors with PTC resistor require an additional external trigger unit for the built-in thermistors. A locking device is recommended to prevent unintentional restart. The test voltage at the thermistors must not exceed 2.5 V or only current-limited measuring equipment may be used.

When using a star-delta connection, a corresponding time delay must be taken into account.

For motors with direct start and a connected load > 4.0 kW, a starting current limitation (soft start by means of thyristor) may be required.

If frequency converters are to be used for speed control, note the following regarding external rotor fans:

All-pole sinusoidal filters must be installed between the frequency converter and the fans (sinusoidal output voltage! Filter effect between phase to phase and phase to earth).

The frequency converters of the Güntner company are equipped with this function as a standard. Three-phase standard motors are suitable for direct operation with frequency converters.

Three-phase fan motors can be operated by means of star-delta connection or with speed control. Check the direction of rotation. A change in the direction of rotation in the event of an incorrect direction of rotation is achieved by swapping two phases.

EC technology

Please inform yourself about general differences between EC and AC technology.

The fan motors have their own electronic power unit. This power unit can be controlled via the Güntner Motor Management GMM / aicore™ air. Depending on the fan/motor type, the motors can be operated either from single-phase (1~, 200 – 277 V AC, 50/60 Hz) **or** three-phase supply (3~, 380 – 480 V AC, 50/60 Hz). Operation without aicore™ air requires fan control with a voltage of 0 – 10 V. Available status and alarm relays: max. 230 V – 2 A / **at least 10 mA (2.3 W)**. For the connected loads, refer to the connection diagrams or the nameplate on the unit or the fan.

3 Safety

3.1 Intended/improper use

3.1.1 Intended use

Condensers, gas coolers or fluid coolers of the Flat/Vertical COMPACT product family and line are intended for installation in a refrigerating plant and a cooling plant respectively, and for outdoor installation. The condenser liquefies the refrigerant through heat dissipation into the air that is conveyed by the fans over the dry heat exchanger surface. The gas cooler is intended for cooling CO₂ gas (transcritical summer operation) and for liquefying and subcooling CO₂ gas (subcritical winter operation) respectively with air for outdoor installation. The fluid cooler cools the heat carrier through heat dissipation into the air that is conveyed by the fans over the dry heat exchanger surface.

The operator of the system determines the operating point.

The nameplate indicates the state of matter of the fluid (liquid/gaseous), the fluid group (hazardous/non-hazardous), the permissible pressure and the temperature.

The machine must be operated in the professional sector.

3.1.2 Operating conditions

Safety measures

Observe the following to avoid personal injury, environmental damage and damage to property in acc. with the state of the art:

- The unit must be used only in acc. with the proper intended use.
- Maintain and clean the unit regularly (see section "Maintenance and cleaning").
- Ensure that the working fluid and unit type do not deviate from the information specified in the order documents when operating, monitoring and maintaining the system.
- Ensure that maintenance measures are performed in compliance with the system's operating instructions.
- Operate the unit only with the working fluids indicated on the nameplate (fluid group and state). Filling the unit with a different fluid is permitted only with the prior written consent of the manufacturer.
- Certain working fluids may be used only in conjunction with specific materials. Pay attention to the exact unit name in chapter "Types of Flat/Vertical COMPACT".
- The maximum permissible operating pressure stated on the nameplate must NOT be exceeded.
- Do not perform any work on the unit without using the personal protective equipment (PPE) specified in these instructions.

3.1.3 Improper use

General

The unit is being used improperly if:

- an unspecified working fluid, an unspecified pressure, an unspecified temperature and/or an unspecified connecting piping not prescribed in acc. with the instructions are used,
- the unit is not completely disconnected for cleaning/maintenance purposes,
- the main dimensions, weight, distances and recommended fixing sizes are not taken into account/adhered to during mounting,

- the supply line (electric) is fused or dimensioned incorrectly on site,
- the wrong fixing elements or not all of the fixing points provided were used for mounting,
- the unit is operated in an environment or for capacity requirements (e.g. aggressive/corrosive environment; capacity range) the unit with its material combination or capacity is not designed for, or which do not correspond to the intended use.

Improper modifications

The unit must not be modified without prior written consent of Güntner GmbH & Co. KG. Modifications to the unit are:

- Change of the operating point (the specified operating point is indicated in the order-related documents)
- Changing the fan capacity (air volume)
- Changing the volume of the working fluid passing through
- Changeover to a different working fluid
- Modification to load-bearing components or the casing (remodelling/changes)

Improper operation

The unit must not be operated if it is damaged or shows signs of faults. All damage and faults must be reported to Güntner GmbH & Co. KG immediately and must be rectified without delay.

3.2 Labelling on the packaging/the unit

3.2.1 Packaging overview

Module A

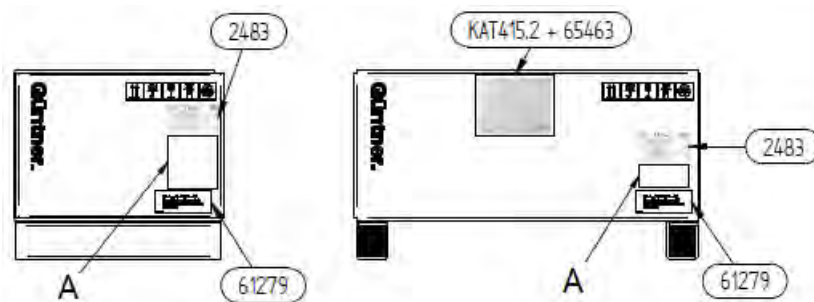

Packaging: Side and front view

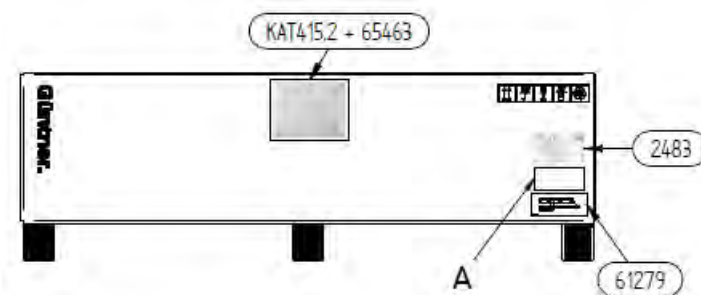

Packaging: Front view with more than one fan

A – Intralogistics label

Modules B, C and D

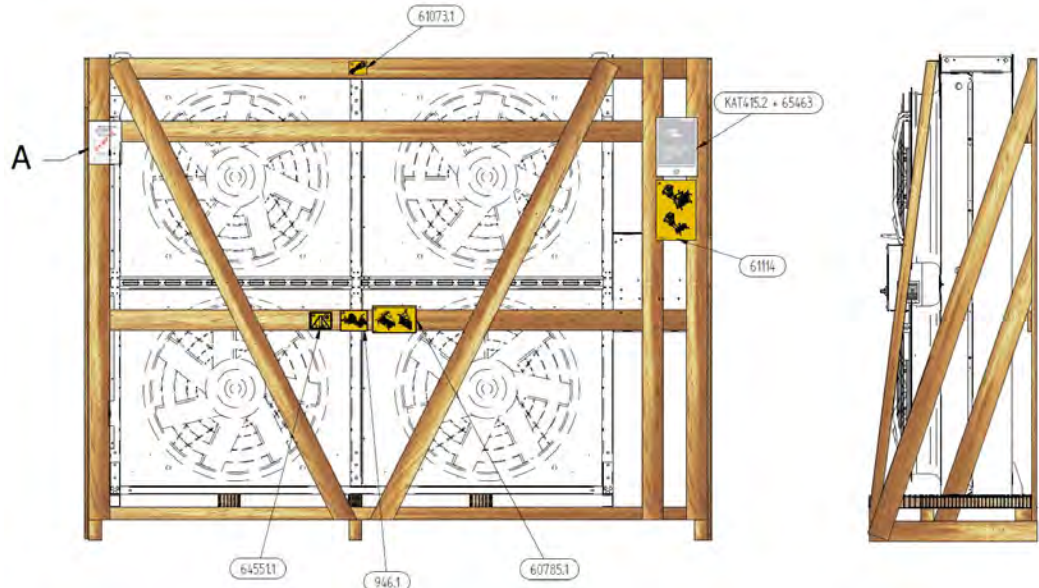

Packaging Vertical – side and front view

finoox

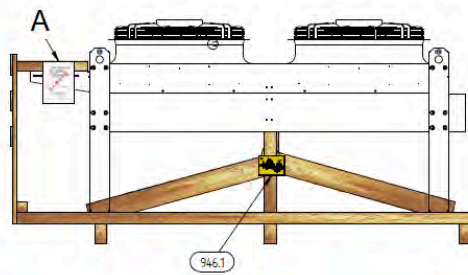

Packaging Flat – side and front view

A – Intralogistics label

3.2.2 Signs and notes on the packaging



61279 – Güntner address (module A)



706** – Güntner logo (module A)

Güntner GmbH & Co. KG
 Hans-Güntner-Straße 2 - 6
 82256 Fürstenfeldbruck
 www.guentner.de

CE 0036 PED *

UK CA 0168 PE(S)R *

EAC

Projektnummer - Project number	101164186	
Gerätebezeichnung - Unit name	S-AGHN 080.2H/210-HND/12P.E	
Gerät Seriennummer - Unit serial number	405167157/43.01256	
Ventilator/ID/Drehzahl/Stromaufn. - Fan/ID/Speed/Current	VT03059U.2 / 3241 / 865 min -1 / 2,1 A	
Umgebungstemperatur - Ambient air temperature	-30 °C / +50 °C	
Herstellungsjahr - Year of manufacture	2022	
* Druckgerät Seriennr. - Pressure equipment serial no.	405167182/43.01264	
Volumen - Volume (V)	108.9l	
Max. zulässiger Druck (PS) Max. permissible pressure (PS)	32 / 0 bar	0 / -1 bar
Zulässige min./max. Temperatur (TS) Permissible min./max. temperature (TS)	-50 °C / +150 °C	-50 °C / +40 °C
Prüfdruck(PT)/Prüfmedium - Test pressure(PT)/Test medium	35.2 bar / Druckluft - Compressed air	
Prüfdatum - Test date	20.01.2022	
Fluidgruppe / Zustand - Group of fluid / State	1 / gasförmig - gaseous	

2483 – Nameplate – **Sample image** (module A)

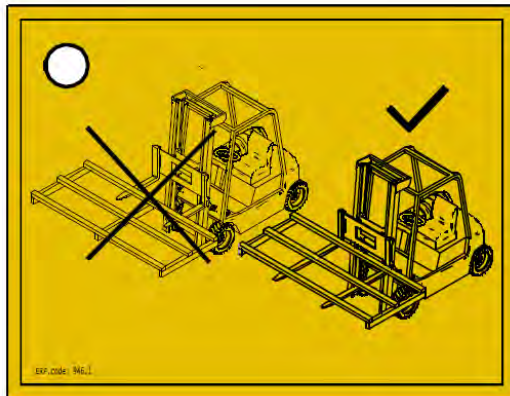

946.1 – Transport with industrial truck with forks



65463 – Shipping documents pocket

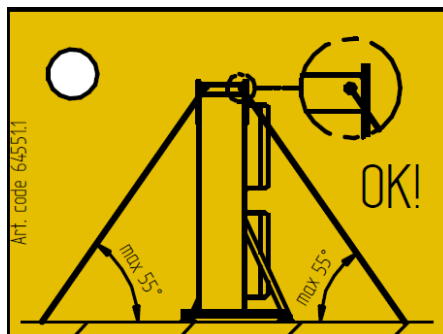

64551.1 – Note on anchoring (modules B, C and D)

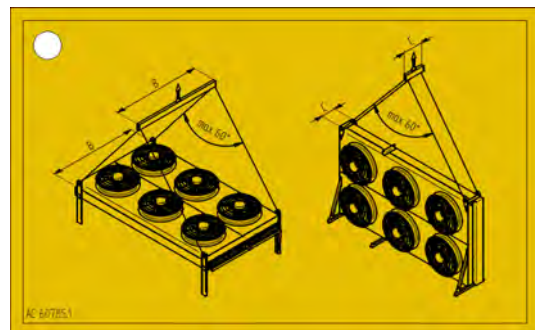

60785.1 – Transport regulation (modules B, C and D)

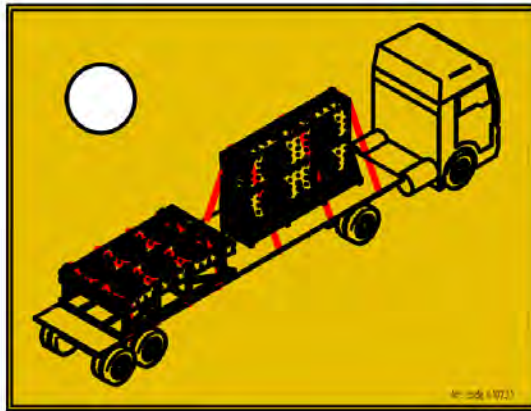

61073.1 – Lashing eye (modules B, C and D)

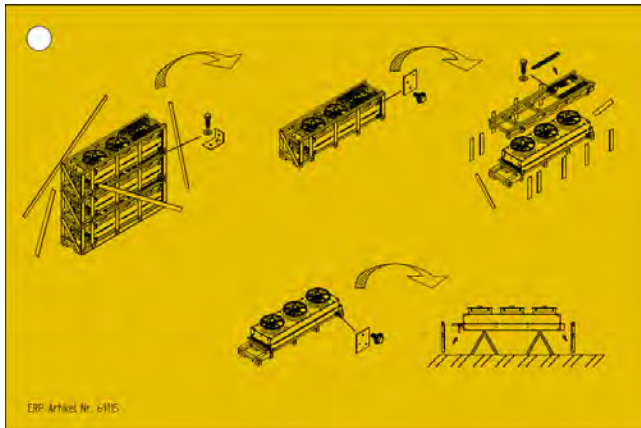

61115 – Removal of packaging when delivered in container (modules B, C and D)



KAT415.2 – Quick Installation Guide

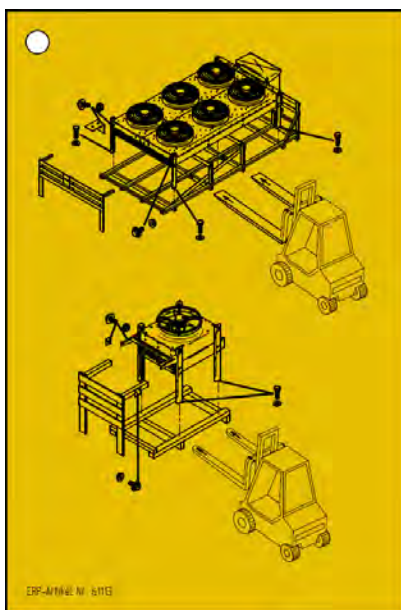

61113 – Unpacking of condensers/dry coolers Flat (modules B, C and D)

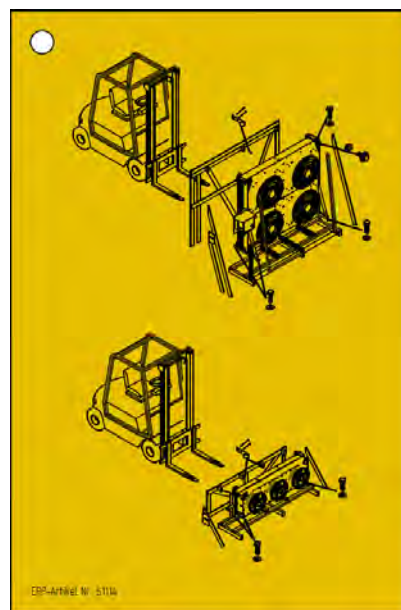

61114 – Unpacking of condensers/dry coolers Vertical (modules B, C and D)

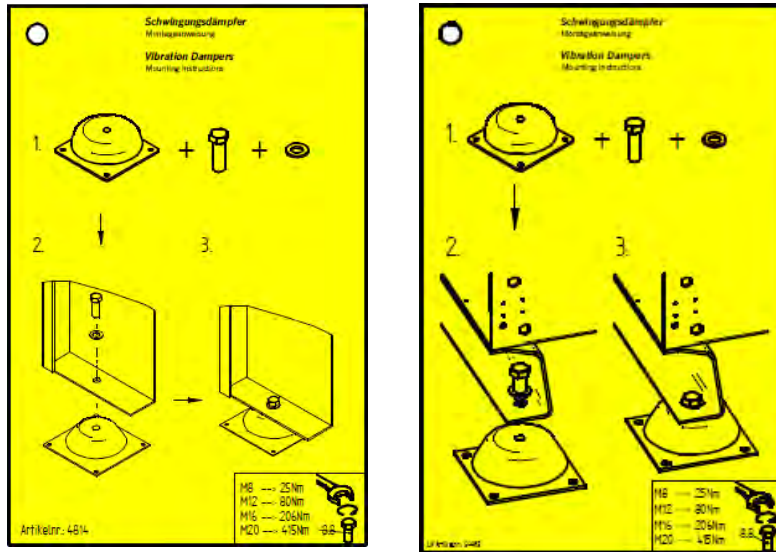

4814, 64493 – Note on vibration dampers (only for GCVC and GCHC, modules B, C and D) (optional)

3.2.3 Unit overview

Module A

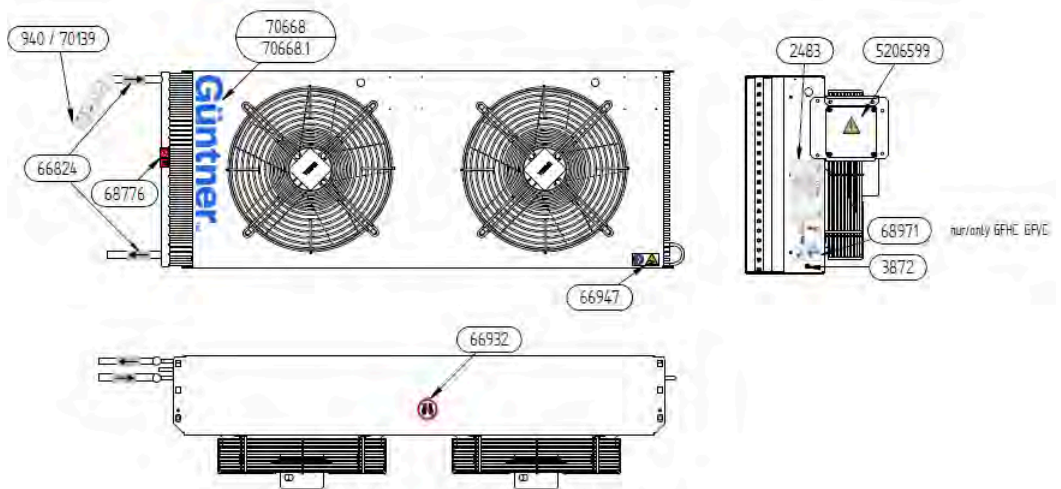

Placement of the markings on the GCVC unit (module A)

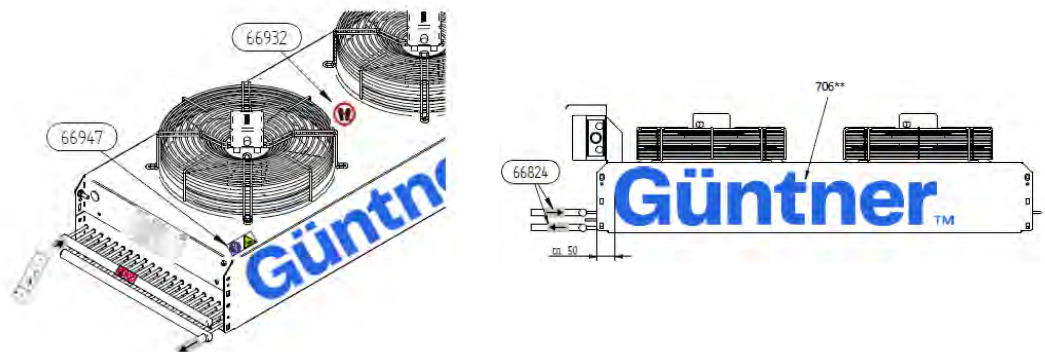

Placement of the markings on the GCHC unit (module A)

Placement of the markings on the GCHC unit (module A) – side view

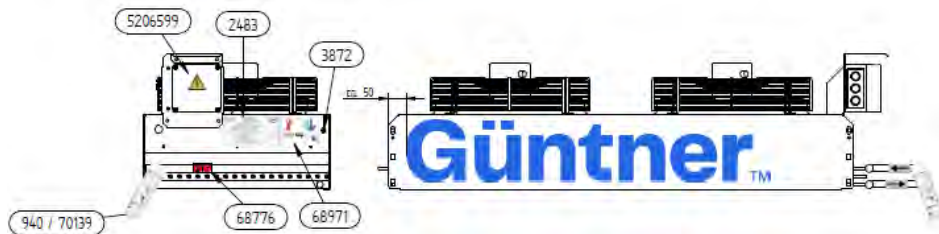

Placement of the markings on the GCHC unit (module A) – side views

Modules B, C and D

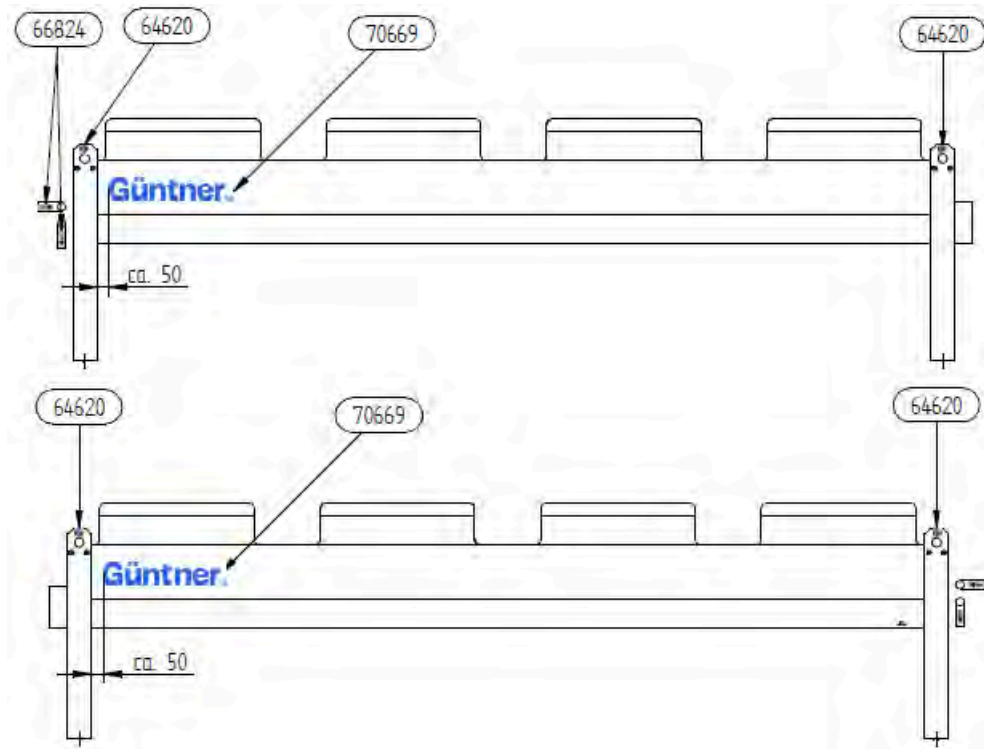

View A and B (Flat)

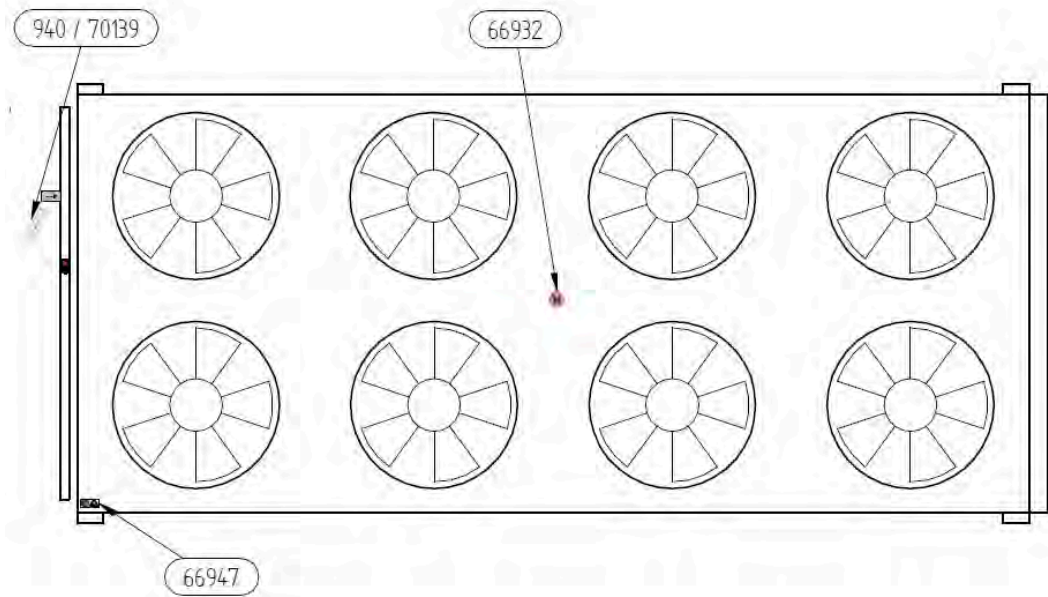

Top view (Flat)

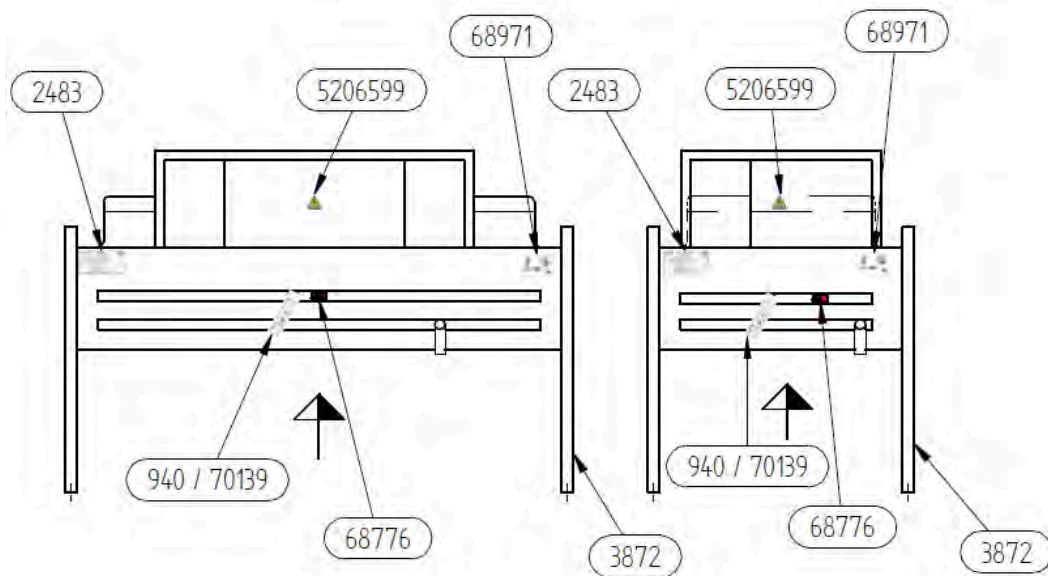

Side views double-row and single-row (Flat)

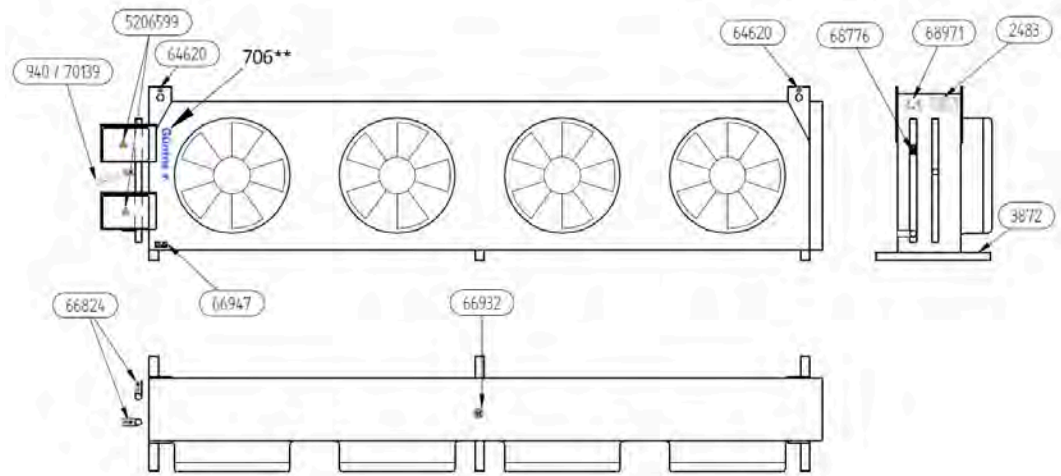

View single-row (Vertical)

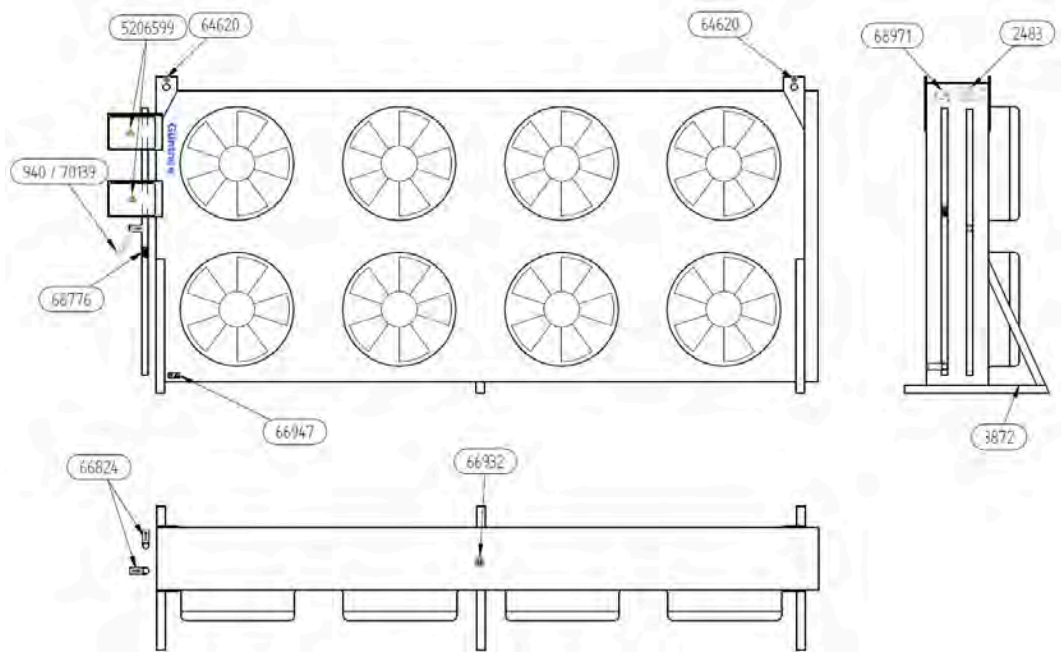

View double-row (Vertical)

3.2.4 Safety signs on the unit

Specific safety signs on the unit:

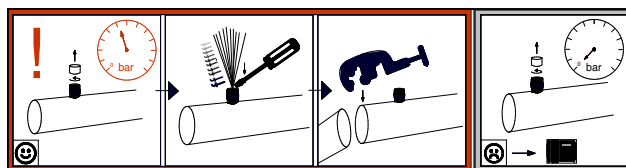

940 – Transport filling at Schrader valve

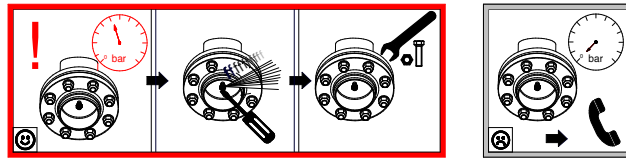

70722 – Transport filling (modules B, C and D)

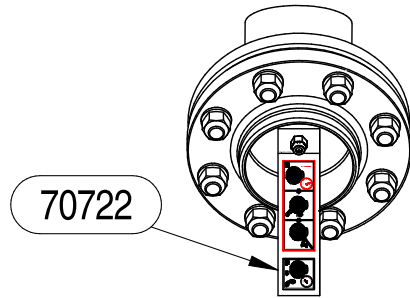

70722 – Transport filling (modules B, C and D)



66932 – No stepping onto the surface



66947 – Inspection cover/inspection door: “Disconnect completely before working”, “Warning of risk of crushing”



60325, 68776 – Do not load, do not lift



64620 – Lifting point (modules B, C and D)



5206599 – Warning of electric shock

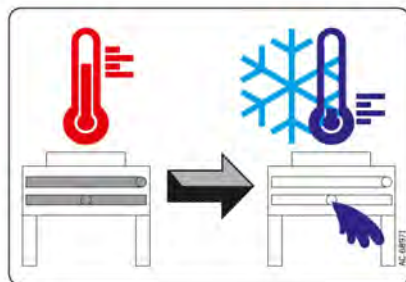

68971 - Danger of frost for dry coolers in general (only for dry coolers/flange connection, only for GFHC and GFVC)

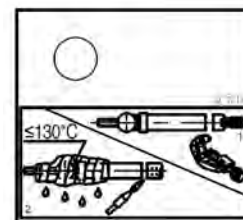

70139 – Tags for CO₂ connection

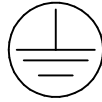

3872 – Earthing marking. The earthing marking in the drawing (connection side of the unit) shows the earthing point for earthing connection by customer. The earthing connections on the unit itself are also marked with this label (not shown in the drawing).

3.2.5 Other signs and notes on the unit

Güntner GmbH & Co. KG
Hans-Güntner-Straße 2 - 6
82256 Fürstenfeldbruck
www.guentner.de

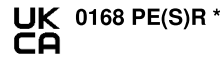
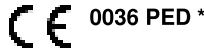

Projektnummer - Project number	101164186	
Gerätebezeichnung - Unit name	S-AGHN 080.2H/210-HND/12P.E	
Gerät Seriennummer - Unit serial number	405167157/43.01256	
Ventilator/ID/Drehzahl/Stromaufn. - Fan/ID/Speed/Current	VT03059U.2 / 3241 / 865 min ⁻¹ / 2,1 A	
Umgebungstemperatur - Ambient air temperature	-30 °C / +50 °C	
Herstellungsjahr - Year of manufacture	2022	
* Druckgerät Seriennr. - Pressure equipment serial no.	405167182/43.01264	
Volumen - Volume (V)	108.9 l	
Max. zulässiger Druck (PS) Max. permissible pressure (PS)	32 / 0 bar	0 / -1 bar
Zulässige min./max. Temperatur (TS) Permissible min./max. temperature (TS)	-50 °C / +150 °C	-50 °C / +40 °C
Prüfdruck(PT)/Prüfmedium - Test pressure(PT)/Test medium	35.2 bar / Druckluft - Compressed air	
Prüfdatum - Test date	20.01.2022	
Fluidgruppe / Zustand - Group of fluid / State	1 / gasförmig - gaseous	

2483 – Nameplate – **Sample image**



706** – Güntner logo (white colour for dark unit colour)



66824, 68909 – Inlet/outlet connections

3.3 Basic safety instructions

3.3.1 Please note

NOTICE

Only persons who meet the requirements for the personnel may work in the area of the unit (see section "Definition of the target group and requirements"). The operator must prevent persons under the age of 14 and unauthorised persons from gaining access to the unit.

NOTICE

Prior to all work on the unit and in case of danger respectively:

- Completely disconnect the unit and secure it against unintentional restart (lockable emergency stop switch is available or must be provided by the customer)
- Refer to the order documents for the permissible working fluid
- Observe the safety data sheets for the working fluid
- Wear personal protective equipment (PPE)

3.3.2 Electrical hazard

⚠ DANGER



ELECTRICAL VOLTAGE!

A short-circuit on the electrical connections and direct or indirect contact with live parts of the unit (including accessories and supply lines) can cause severe injury or even death. In addition, overvoltage or overheating of the electrical parts installed in the unit can result in fires which in turn can cause smoke inhalation injuries among bystanders.

The risk of electric shocks and short circuits increases with the degradation of insulating material due to environmental influences or mechanical and/or deliberate damage.

- Completely disconnect the supply line before performing electrical work on the unit (see the documentation for the plant as a whole).
- Work on the unit and the connection and control configuration must be performed by specialist staff.
- Check electrical components regularly, including testing in acc. with EN 60364-x/EN 60204-1. Consider the information provided in the connection diagram.
- Properly connect the unit to the building's earthing system.
- Perform earthing checks and visual inspections of the earthing points regularly.
- Provide adequate lightning protection.













3.3.3 Hazard due to working fluids

Working fluids pose various residual risks such as irritation, suffocation, poisoning, burns, frostbite, fire hazard and/or explosion hazard. Observe the following safety measures:

- Observe the safety data sheet of the working fluid.
- Comply with the safety regulations for the system in acc. with the EN 378 series of standards.
- Observe the pressure and temperature specified on the nameplate.

- Observe the type of fluid, the fluid charge and material selection in acc. with the technical data.
- Before performing any maintenance work, ensure that the unit is depressurised. Completely drain any working fluid from the unit if necessary.

⚠ WARNING		
	<p>EXPLOSION HAZARD! FIRE HAZARD! RISK OF SUFFOCATION! RISK OF POISONING! RISK OF FROST-BITE! RISK OF CHEMICAL BURNS!</p> <p>When working on the pipes of the heat exchanger (e.g. soldering or welding work), or if the flammable working fluid escapes through leaks and forms an explosive mixture over time, the working fluid catches fire or explodes and injures bystanders.</p>	
	<p>Bystanders may inhale the escaped working fluid. Inhaling the working fluid causes anything from breathing problems to suffocation or poisoning.</p>	
	<p>Contact with the working fluid can cause frostbite and/or irritation and chemical burns (e.g. ammonia combined with water).</p>	
	<p>Leakage of the working fluid can also lead to environmental damage.</p>	
	<ul style="list-style-type: none"> • Drain the unit prior to work and for transport respectively. • Ensure that the operator provides appropriate fire-fighting equipment for soldering and welding work. • Ensure that the plant is designed in such a way that the unit can be filled/emptied safely. • Do not fill with a working fluid other than that specified in acc. with the order documents! • Take measures to prevent high working fluid concentrations on site. • Check the unit regularly for leaks and leakage (see section "Inspection/maintenance schedule"). Avoid leaks and leakage and, if necessary, have them fixed as quickly as possible by an expert. • Only put the unit back into operation when all leaks have been repaired. • Pay attention to the risk of ignition of oil residues carried over. • Avoid all sources of ignition when working! • Observe all applicable standards and directives with regard to waste disposal. • Wear personal protective equipment (PPE), including respiratory protection if necessary (see safety data sheet for the relevant working fluid). 	
		

ATTENTION

RISK OF FREEZING!

Units filled with a heat carrier can be damaged or destroyed in frost if adequate frost protection measures have not been taken. There is a risk of freezing during pressure testing, operation, standstill or after draining units that cannot be completely drained.

- Ensure that the antifreeze concentration is sufficient.
 - Caution!** The operator must ensure that the antifreeze concentration is sufficient.
- When draining, the unit must be sufficiently ventilated!

3.3.4 Hazard due to vibrations

⚠ WARNING



EXPLOSION HAZARD, FIRE HAZARD, RISK OF PERSONAL INJURY AND DAMAGE TO PROPERTY CAUSED BY EJECTED OBJECTS!

A component, a chunk of ice or the complete fan unit loosens because of vibrations/oscillations/imbalance and

- injures bystanders or
- is thrown out of the unit by the fan's rotating movement and damages the heat exchanger whereby
 - the working fluid escapes and gets onto the skin of bystanders and/or is inhaled by bystanders (see section "Hazard due to working fluids"), or
 - the working fluid ignites (with flammable working fluids) and injures bystanders, or
 - a core tube that is under pressure explodes and the resulting pressure wave injures bystanders.



Take the following measures:

- Fans, components and pipes in the system must be designed, constructed and integrated in such a way that risks caused by vibrations are reduced to a minimum.
- Connect the fans in acc. with the motor connection diagram in the terminal box, check the connection and perform acceptance test of the fans.
- Check the fan unit regularly in acc. with the inspection and maintenance schedule.
- Keep the unit free of ice.
- Check the unit and especially the proper functioning of the fans after standstill periods (particularly in the event of snow and freezing rain).
- To further reduce the transmission of vibrations from the unit to its surroundings, additional vibration dampers can be installed by the customer between the unit and the ceiling.

⚠ WARNING



ADVERSE HEALTH EFFECTS AND DAMAGE TO PROPERTY CAUSED BY VIBRATIONS!

The operation of fans regularly causes vibrations that are increased by imbalances resulting from impurities or damage of fan blades. These vibrations are transmitted to the building and the unit and can result in damage to the building and the unit, and to the unit's suspension, the pressurised pipes/components and the system's components connected to the unit.

This can result in leakage of the working fluid and adverse health effects (see section "Hazard due to working fluids").

- Check the fan blades and protection guards regularly for impurities and snow accumulation, and make sure the fans run smoothly.
- To further reduce the transmission of vibrations from the unit to its surroundings, additional vibration dampers can be installed by the customer between the unit and the ceiling.

3.3.5 Hazard due to pressurised parts

⚠ WARNING









EXPLOSION HAZARD! PERSONAL INJURY AND DAMAGE TO PROPERTY DURING OPERATION OR MAINTENANCE!

The pressure in the heat exchanger exceeds the specified limit values (e.g. due to improper installation) and results in an explosion or breakage of pressurised pipes/components. This causes objects to be ejected and/or working fluid to be released, resulting in personal injury or damage to property.







- Comply with all regulations regarding installation, operation, maintenance and maximum permissible operating pressure.
- Drain the unit prior to work and for transport respectively.
- Ensure that the operator provides appropriate firefighting equipment for soldering and welding work.
- Ensure that the plant is designed in such a way that the unit can be filled/emptied safely.
- Ensure that relief devices against liquid expansion are in place (if applicable).
- Ensure that subcooled liquid is present only to a minimal extent in parts of the system when the refrigerating plant is at a standstill – by minimising the number of “dead end traps”.





3.3.6 Thermal hazard

⚠ WARNING		
 	<p>RISK OF BURNS OR RISK OF FROSTBITE! Contact with the working fluid (e.g. during filling/drain- ing) or with the unit surface or pipes can cause severe burns/frostbite.</p> <ul style="list-style-type: none"> • Wear personal protective equipment (PPE). • Retrofit a thermal insulation to the pipes and the connection system as required. • If necessary, wait until the temperature has equalised to the ambient temperature before start- ing to work. 	 







3.3.7 Mechanical hazard

⚠ WARNING	
	<p>RISK OF INJURY! Due to overloading or external influences such as extreme, impermissi- ble ice loads on the unit, the unit loses its stability and tips over or falls down, or structural failure occurs and the unit breaks apart. Bystanders are seriously injured.</p> <ul style="list-style-type: none"> • In addition, securely anchor vertical units with cables. • Install the units at the corresponding fixing points. The operator or installer is responsible for ensuring that the connecting elements (screw connections) are of an adequate strength. • Tighten the fixing bolts evenly to achieve an even load distribution on the unit's fastenings. • Anchor the unit in its fixing position to prevent it from moving. • Secure fixing bolts against loosening by means of appropriate locking devices. • Regularly check all fixing bolts and attachments for corrosion damage, loading-bearing capacity and structural integrity, and replace them if necessary, especially before and after lifting the unit.



 WARNING		
  	<p>RISK OF SLIPPING! RISK OF TRIPPING! RISK OF FALLING!</p> <p>A person slips when accessing the unit or on the ladder or on the unit surface, or trips over a protruding part and falls.</p> <ul style="list-style-type: none"> • Arrange the unit's surroundings in such a way as to ensure safe access and safe working on the unit at all times – even in adverse weather conditions. • Check all fixing bolts and fixing devices regularly and especially before and after lifting the unit for corrosion damage, load-bearing capacity and structural integrity, and replace them if necessary. • Watch out for obstacles and tripping hazards. • Appropriate fall protection measures must be taken by the operator or operating personnel. • Observe the maintenance schedule. • Please note the following before stepping onto the unit surface (e.g. for maintenance and servicing): <ul style="list-style-type: none"> ◦ Wear personal protective equipment (work gloves and slip-resistant safety shoes or safety shoes with slip-resistant overshoes). ◦ Stepping onto the unit surface is permitted only if appropriate fall protection is in place. ◦ Check the unit surface for snow/ice and remove it if there is any. ◦ In bad weather conditions (water on the unit, clear ice, gusts of wind), take particular care when walking on the unit surface! ◦ Never step on the fans. ◦ Always maintain a safety distance from the edges when walking on the unit. ◦ The fall protection (railing and ladder construction) must be attached to the unit by specialist staff in acc. with the manufacturer's instructions. ◦ The fastening elements of the fall protection (railing and ladder construction) may be used only once, i.e. new fastening elements must be used for each assembly/disassembly. Tighten all setscrews applying a tightening torque of 40 Nm. ◦ It is the responsibility of the operator to ensure that the ladder is secured against unauthorised climbing. Access only for persons who have permission from the operator and are appropriately trained. 	  

⚠ WARNING		
 	<p>RISK OF CUTTING AND CRUSHING!</p> <p>Persons can cut or otherwise injure themselves on the packaging (e.g. wood) or on sharp edges of the unit (e.g. sheet metal edges/fins) or the accessories. There is a risk of crushing when the unit is open.</p> <ul style="list-style-type: none"> • Wear personal protective equipment (PPE). • The hinged or removable components (e.g. side plates (if any)) may be opened only by trained specialist staff and only for the purpose of maintenance and repair. Once the work has been completed, the components must be closed and secured against unintentional or unauthorised opening. 	 

3.3.8 Hazard due to fans











⚠ WARNING		
  	<p>DANGER OF PULLING IN, RISK OF CRUSHING AND DANGER OF CUTTING OFF!</p> <p>Limbs can be caught by the running fan and injured (e.g. crushed) or severed. Hair and clothing can be pulled in the running fan and cut off.</p> <ul style="list-style-type: none"> • Completely disconnect the unit and secure it against unintentional restart before performing any work. A lockable repair switch is available or to be provided by customer. Attach an appropriate warning label to the unit. • Ensure that the fans are connected in acc. with the motor connection diagram in the terminal box, then perform an acceptance test of the fans. • Operate the fans only with protection guards. • The protection guards must be opened by trained specialist staff and only for maintenance and repair purposes. • Check the fan unit regularly in acc. with the inspection and maintenance schedule. • Do not wear any loose clothing or jewellery. Secure long hair on the head. • Wear personal protective equipment (PPE). • Stop the unit immediately if a missing or ineffective safety device is detected. • Check the unit and especially the proper functioning of the fans after standstill periods. • Keep the unit free of ice. • Operate the unit only with safety devices. 	  

3.3.9 Other hazards

 WARNING		
	<p>RISK OF HEARING DAMAGE! Persons who spend long periods in the vicinity of the unit can suffer hearing damage, discomfort and stress as the unit produces noise levels (sound pressure levels) of over 70 dB(A).</p> <ul style="list-style-type: none">• Wear personal protective equipment.• Observe the requirements of local authorities.• The manufacturer of the system is obliged to position the unit in such a way that noise pollution is minimised. In addition, further suitable measures must be taken to minimise noise.	

4 Transport and unpacking

4.1 Safety instructions for transport and unpacking

⚠ WARNING		
	<p>RISK OF INJURY OWING TO STRONG IMPACTS! RISK OF CRUSHING AND SHEARING!</p> <p>The following hazards may occur:</p> <ul style="list-style-type: none"> • When transporting or manoeuvring the means of transport, bystanders are caught by the unit. This causes serious impact injuries, or limbs are sheared off/crushed. • Bystanders get under the unit or are caught by a falling component/unit and lose limbs or are crushed. • The unit loses its stability due to accelerations during transport and falls over or falls from the goods vehicle. Bystanders are seriously injured. • Attempting to transport the unit by hand causes injury (e.g. to the spine) due to the lifting of an overload. <p>Take the following measures:</p> <ul style="list-style-type: none"> • Transportation including loading and unloading only by specialist staff. • Do not stand in the loading/danger zone under or in the vicinity of suspended loads. • Ensure that the unit is protected against slipping and mechanical damage. • Remove foreign material before lifting the unit, and sweep off snow. • Ensure that the unit is not filled during transport. • Suspend or position the unit so that it has a stable centre of gravity. • Use appropriate lifting or tie-down points. • Use suitable tools and working equipment. • Do not lift the unit in strong winds. • Observe maximum permissible total weight. • Wear personal protective equipment. • Not intended for carrying by hand. 	
		
		
		
		
		

ATTENTION
<p>The lifting capacity of the means of transport must be at least 1.5 times the weight of the unit.</p> <p>Do not use connection pieces and outlet headers as attachment points for lifting, pulling, fixing and climbing. This can result in leakage.</p>

NOTICE
<p>Observe all basic safety instructions (see section "Basic safety instructions").</p>

4.2 Transport and storage of the unit

4.2.1 Transporting the unit

NOTICE

Read and observe the transport signs on the unit packaging!
Permanent mechanical load caused by uneven road surfaces and potholes, and vibrations during ship transport, can result in transport damage.

- Mounted parts that can be induced to vibrate – particularly fans and bases (if applicable) – must be removed prior to maritime transport or in countries with critical traffic routes.
- Supports of outlet headers and flanges must be added if required.
- After transport, check all bolted connections, especially on EC fan terminal boxes, and retighten them if necessary (for tightening torque values, see section "Fans").

Industrial truck with forks

NOTICE

Before lifting the pallet with an industrial truck with forks, slide the forks far enough underneath the open spaces of the pallet so that they reach to the end of the pallet.

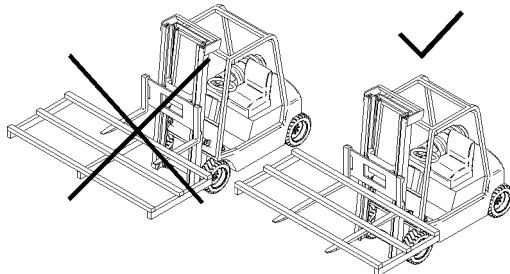

NOTICE

When moving the unit with industrial trucks with forks, ensure that the unit is fully supported on the forks.

To prevent paint damage to the unit, prepare the forks of the industrial truck adequately before lifting (e.g. by placing rubberised pads on them).

During transport with industrial trucks with forks, avoid impact loads due to uneven surfaces and jerky starting and braking.

Crane

NOTICE

When transporting the unit with a crane, pay attention to the angle between the cables/chains/loops.

If too great an angle is allowed between the cables/chains/loops when transporting with a crane, this can lead to excessive mechanical stress on the crane lugs, which can break in extreme cases, causing the unit to fall down.

Observe the following regulations when transporting with a crane:

- ⇒ Use the drill holes for the eyes.
- ⇒ Ensure that the cables/chains/loops do not rub against the legs or other components.
- ⇒ The angle between the cables/chains/loops must not exceed 60°.
- ⇒ The cables/chains/loops must pull upwards as straight as possible when viewed from the front.
- ⇒ Prevent any vibration of the unit.
- ⇒ Use a lifting beam (lifting capacity > 5 tonnes).

4.2.2 Storing the unit prior to installation

- ⇒ Protect the unit against dust, dirt, moisture and wetness, damage and other harmful influences until it is mounted.
- ⇒ For storage periods of more than one month: Operate the fans at least once a month at full speed for at least three hours so that the bearings move and any penetrated condensate can evaporate. Check, once a month and prior to installation, if the transport pressure is still present to ensure that the unit is leak-tight. If the pressure is too low or if there is no transport pressure at all, be sure to contact the service department of the manufacturer. Before moving the unit to the installation site, check the load capacity and structural integrity of the crane lugs and replace them if required. Store the unit only in its original packaging until installation.
- ⇒ If the unit installation is delayed beyond the initial deadline scheduled for installation: Protect the unit against weather and other harmful effects and dirt with an appropriate tarpaulin. In this context, ensure good ventilation of the unit.

4.3 Unpacking the unit

Cardboard packaging

Unit types with module width 500 mm are delivered in cardboard packaging. If several units are delivered, up to four boxes will be stacked for delivery. If several units are delivered: Place boxes on the floor one at a time to unpack the units.

Units

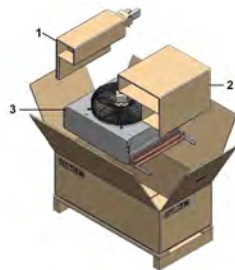

finoox unit with 1 fan

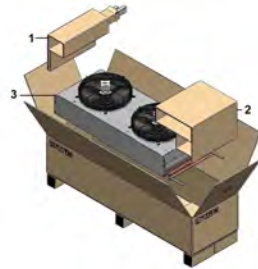

finoox units with 2 fans

- ⇒ Open box, fold the flaps outwards.
- ⇒ Remove the legs (1) supplied loose in a box.
- ⇒ Remove protective cardboard (2).
- ⇒ Lift the unit (3) out of the box.

Wooden packaging

Unit types with module width from 600 mm are delivered in cardboard packaging. If several units are delivered in a container, up to three units are delivered on top of each other. If several units are delivered: Place unit pallets on the floor one at a time to unpack the units.

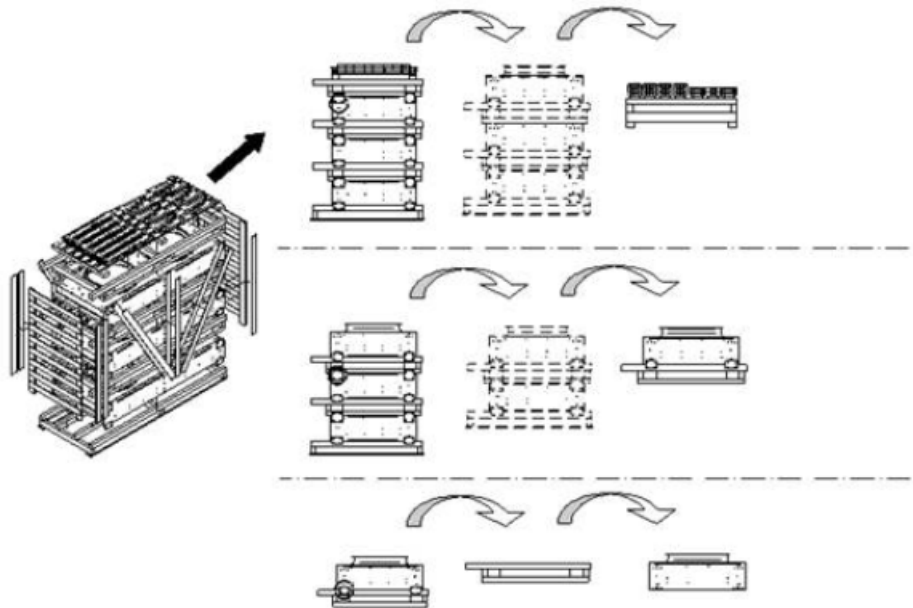

Unpacking of units with wooden crate

- ⇒ Remove outer wooden crate on all four sides.
- ⇒ Lift the top pallet with the legs for floor mounting and the transport brackets from the stack and set it aside.
- ⇒ Lift the pallets with the units individually from the stack and set them aside.
- ⇒ Before lifting the units from the respective pallet: Ensure that all screwed/bolted connections used for packaging are loosened!

Single-row units

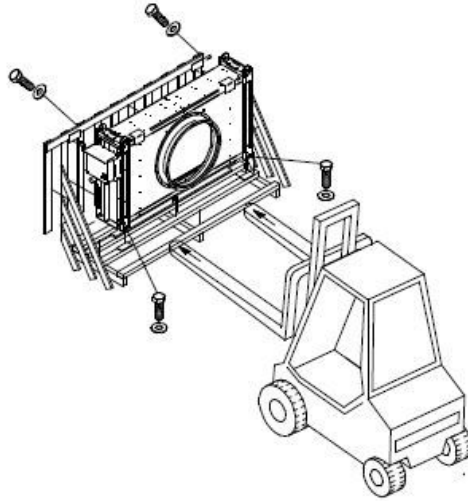

Unpacking vertical units

Double-row units

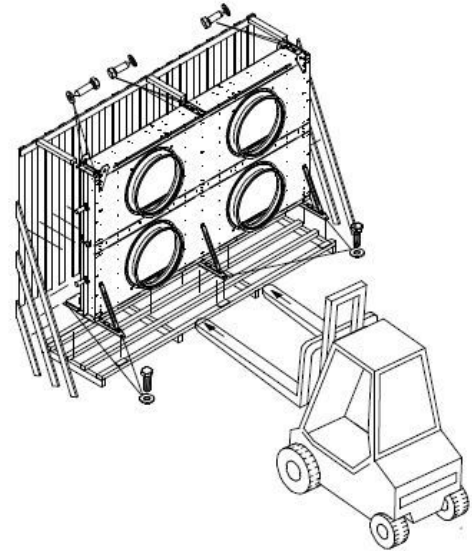

Unpacking vertical units

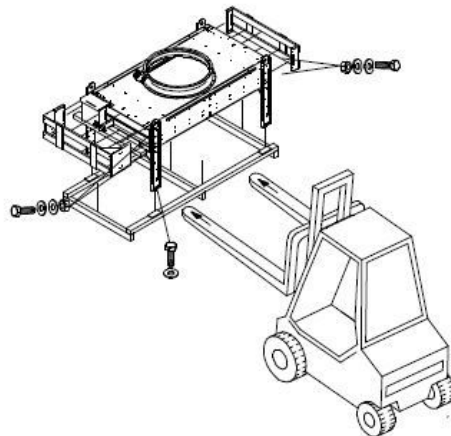

Unpacking horizontal units

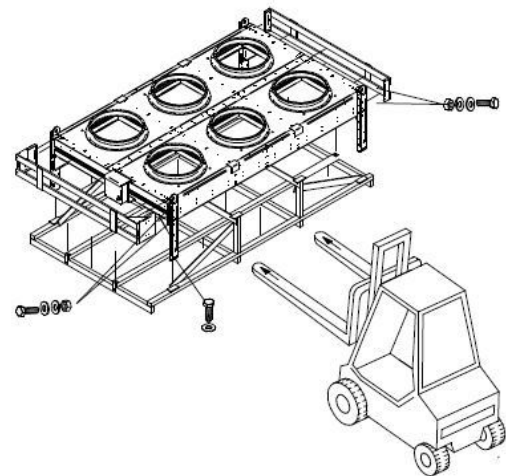

Unpacking horizontal units

- ⇒ Remove all transport safety bolts marked with special tags (see "Other signs and notes on the unit"). After removing the screws/bolts, properly repaint the areas where the screws/bolts were inserted to ensure corrosion protection.
- ⇒ Lift the unit off the pallet and transport it to the place of installation.

After unpacking

- ⇒ Dispose of packaging material.
- ⇒ Check scope of delivery for completeness. For the scope of delivery, refer to the order documents.
- ⇒ State transport damages and/or missing parts on the delivery notes. Immediately notify the manufacturer in writing about the matter. Damaged fins can be repaired on site using a fin comb.
- ⇒ Check the transport pressure (see below).

NOTICE

Güntner GmbH & Co. KG's transport packaging is made from environmentally sound material and is suitable for recycling.

4.4 Checking the transport pressure

Introduction

The section applies only to units supplied with transport pressure.

All units are delivered by the manufacturer with approx. 1 bar of transport pressure (cleaned and dehumidified air). The transport pressure is used to check the leak tightness.

Specific hazards

⚠ CAUTION



RISK OF DAMAGE TO PROPERTY!

The unit is pressurised! An unpressurised unit indicates a leak due to transport damage.

- Do not put the unit into operation!
- Immediately report any pressure drop of the unit to the manufacturer and note it on the delivery note.

Procedure immediately before the installation

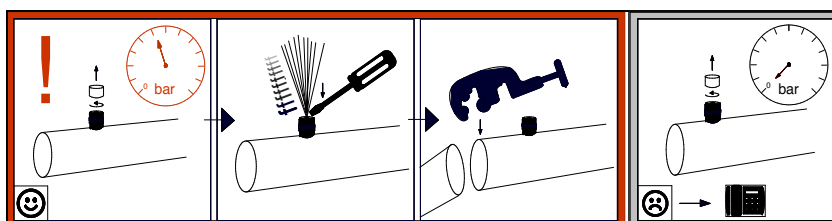

In the case of factory-sealed pipe ends without flanges

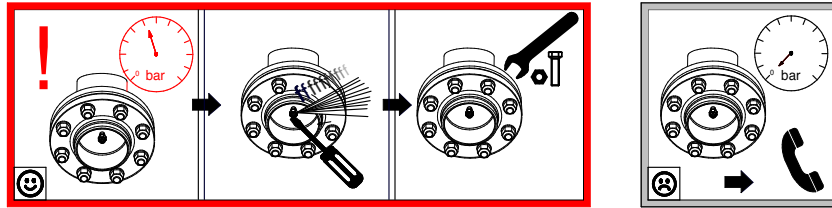

In the case of factory-sealed pipes with flanges

- ⇒ Check the transport pressure (attach a pressure gauge to the Schrader valve and read the pressure) and then release it.
- ⇒ Cut off the sealed pipe ends without flanges from the pipes (e.g. with a suitable saw).
Caution! The sealed pipe ends must not be cut off more than 2 cm from the end.
- ⇒ Unscrew the flanges from the pipes with flanges. The counterflanges can be reused. However, the gaskets and flange bolts must be replaced by the customer.

5 Installation and commissioning



5.1 Safety instructions for installation and commissioning

Please note

NOTICE
Observe the basic safety instructions and the safety instructions for transport (see sections "Basic safety instructions" and "Safety instructions for transport and unpacking").
NOTICE
As a lightning protection measure, conductor antennas next to the units are strongly recommended.
NOTICE
Observe the earthing marking on the unit. Ensure professional equipotential bonding to protect any warranty claims.
NOTICE
Mounting/installation must be performed by competent persons. The manufacturer's warranty does not cover damage resulting from improper installation.
NOTICE
During filling and after filling the system, properly vent the heat exchanger. To do this, keep the vent connections open until no more air escapes from the unit! Observe the safety data sheets of the working fluid used!
NOTICE
After commissioning, document the installation and settings and have them signed by the responsible persons.

Specific hazards

⚠ WARNING	
	<p>RISK OF DAMAGE TO PROPERTY! In order to avoid stray currents, heat exchanger tubes, casing parts and the like must not be used as return line when performing welding work as these load-bearing components and lifting accessories are not designed for high welding currents. If not observed, unintended or improper current flow can damage heat exchanger pipes of the unit and lead to damage during operation.</p> <ul style="list-style-type: none"> Securely connect the insulated welding return line to the workpiece to be welded directly at the welding point.

⚠ CAUTION	
	<p>RISK OF INJURY DUE TO INSULATING MATERIAL! User comes into contact with insulating material or its fixing needles, which causes skin irritations.</p> <ul style="list-style-type: none"> • Wear personal protective equipment.
	
ATTENTION	
<p>RISK OF DAMAGE TO PROPERTY! To prevent damage to the heat exchangers, always connect them without force and torque. There must be no forces or moments acting on the heat exchanger at any time. Failure to observe this can result in leaks and further damage to the heat exchanger in the short and medium term.</p> <ul style="list-style-type: none"> • Ensure that the outlet headers and flanges (if any) are not used as a climbing aid. They are not designed for external forces. • Ensure that no forces or moments act on the heat exchanger at any time by using suitable fixed bearings during pipe installation. 	

5.2 Requirements for the place of installation

Dimensions/weights

For dimensions and weights, refer to the order documents.

Environmental conditions

The unit is designed for the following standard conditions (for deviating data, see nameplate):

- Ambient temperatures ranging from -30 °C to +50 °C

The unit is subject to the following load limits:

- Snow load: GCHC 2.85 kN/m², GCVC 5.19 kN/m²
 Wind load: GCHC 1.14 kN/m², GCVC 1.32 kN/m²
- Snow load: GFHC 2.85 kN/m², GFVC 5.19 kN/m²
 Wind load: GFHC 1.14 kN/m², GFVC 1.32 kN/m²
- Snow load: GGHC 2.85 kN/m², GGVC 5.19 kN/m²
 Wind load: GGHC 1.14 kN/m², GGVC 1.32 kN/m²
- Earthquake load: 0.1 g

The material selection of all components must be suitable for the local conditions.

Installation conditions

- ⇒ Install the unit only outdoors, on a stable and level surface.
- ⇒ The floor of the place of installation must have sufficient load-bearing capacity.

- ⇒ The layout plan must be drawn up by the plant operator.
- ⇒ Position the unit in such a way that it is safe to reach and cannot be damaged by internal traffic or transport processes or by other environmental hazard sources (e.g. processes at the place of installation).
- ⇒ Position the units in such a way that the air flow is not impeded by obstacles.
- ⇒ Place the unit in such a way that that it can be monitored and checked from all sides at all times.
- ⇒ Ensure that sufficient space is available for maintenance.
- ⇒ Ensure that all working fluid-carrying components, connections, shut-off devices and pipes and all electrical connections and lines are easy to access.
- ⇒ Ensure that the labelling of the pipes is easily visible.
- ⇒ The unit must be securely fixed at all fixing points without vibration.

NOTICE

The operator or installer of the equipment is responsible for ensuring that the bolted connections are of an adequate strength.

NOTICE**Risk of corrosion of the vibration dampers and legs for floor mounting**

Installation of the unit in standing water or on surfaces on which water can collect (such as glycol protectors) can result in rust on vibration dampers and legs for floor mounting. Rusting vibration dampers or legs for floor mounting result in instability of the unit.

Installation instructions for condensers and fluid coolers

Horizontal units

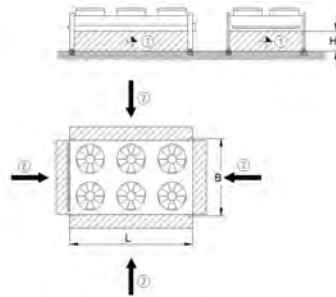

- (1) Air flow direction
- (2) Free area for air intake

$$H \geq \frac{L \times B \times 0,7}{(L + B) \times 2}$$

Free-standing installation

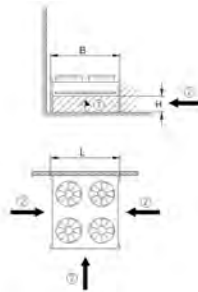

- (1) Air flow direction
- (2) Free area for air intake

$$H \geq \frac{L \times B \times 0,7}{L + (B \times 2)}$$

Installation next to a wall of a building

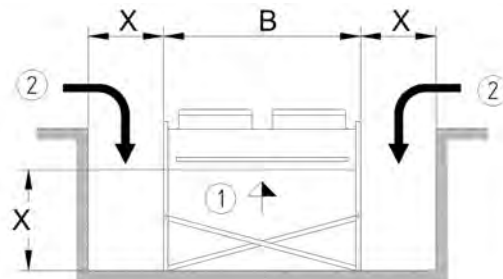

- (1) Air flow direction
 - (2) Free area for air intake
- X ≥ 0.5 x B**

Installation in a recess

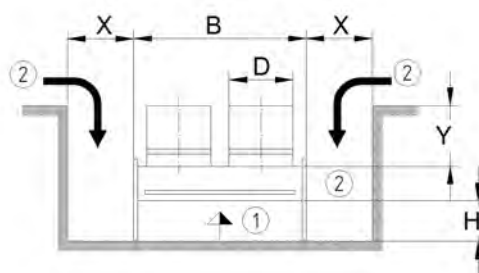

- (1) Air flow direction
 - (2) Free area for air intake
- Y ≤ D**
X ≥ 0.5 x B
H ≥ 0.7 x X

Installation in a recess- air outlet nozzles

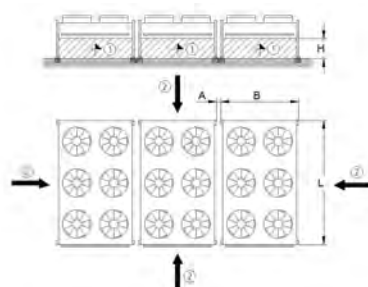

- (1) Air flow direction
 - (2) Free area for air intake
- A_{min} = 80 mm** (necessary because of projection at the vibration dampers)
n = number of units

$$H \geq \frac{n \times L \times B \times 0,7}{(2 \times L) + (n \times 2 \times B) + (n - 1) \times 2 \times A}$$

Combined installation

Vertical units

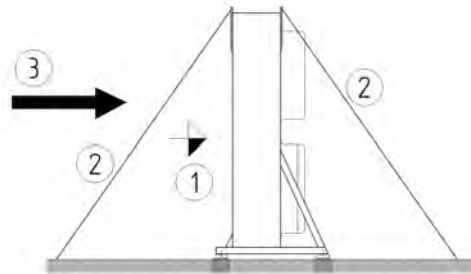

- (1) Air flow direction
- (2) Cable anchoring
- Observe adhesive labels on the unit!**
- (3) Prevailing wind direction

Free-standing installation

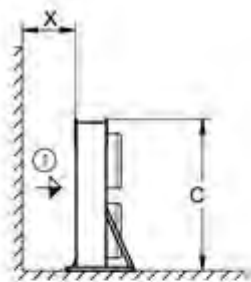

- (1) Air flow direction
- (2) Free area for air intake
- $X \geq 0.35 \times L$**
- $Y \geq 0.5 \times L$**

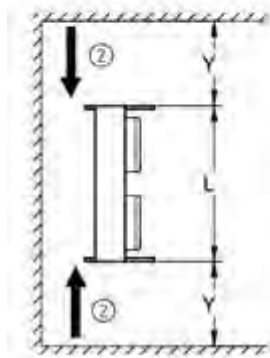

Floor mounting; Side view (top) and top view (bottom)

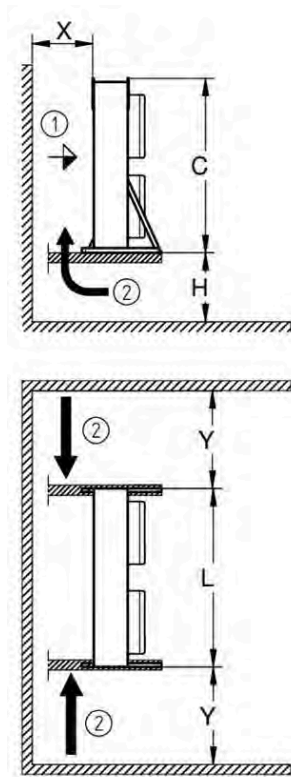

- (1) Air flow direction
 - (2) Free area for air intake
- $Y \geq X$

$$X \geq \frac{L \times C \times 0,7}{(2 \times C) + L}$$

$$H \geq X \times 1.5$$

Wall mounting; Side view (top) and top view (bottom)

5.3 Installation of the unit

5.3.1 Mounting the legs

Leg mounting with single-row units

This applies to the unit types with module width 500 mm that are delivered in cardboard packaging. The legs are supplied loose with the unit.

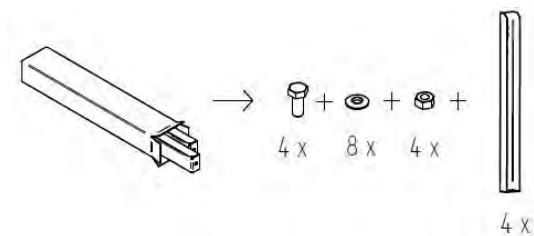

⇒ Check the scope of delivery for completeness.

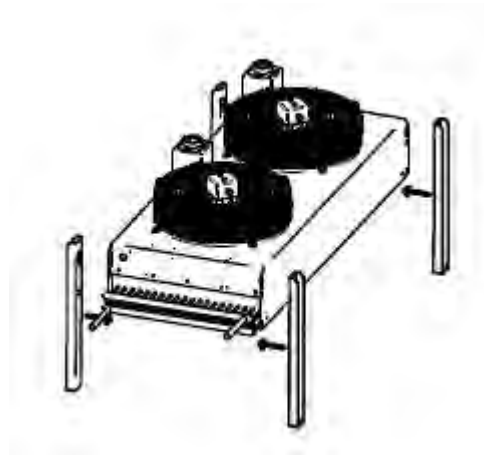

- ⇒ For easier attachment of the legs, place the unit on a level surface with a height at least equal to the length of the legs.
- ⇒ Position the legs on the unit where they are to be screwed in place.

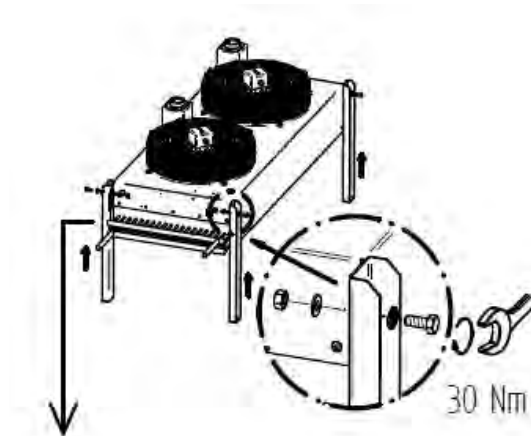

- ⇒ Bolt the legs to the unit.

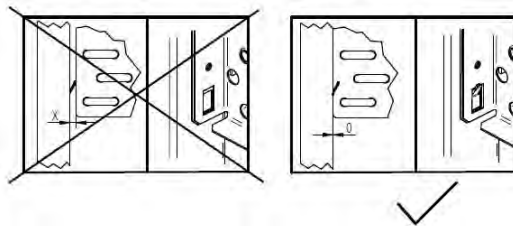

- ⇒ Make sure that there are no gaps between the legs and the unit. The legs must be flush with the unit.

Leg mounting with double-row units

This applies to the horizontal units with module width 600 mm that are delivered in wooden packaging in the vertical position. The legs are supplied loose with the unit.

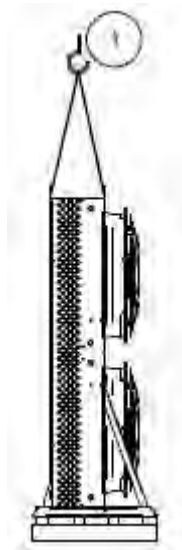

- ⇒ 1. Transport the unit to the intended place of installation. When transporting by crane: Attach cables only to the crane eyes provided.

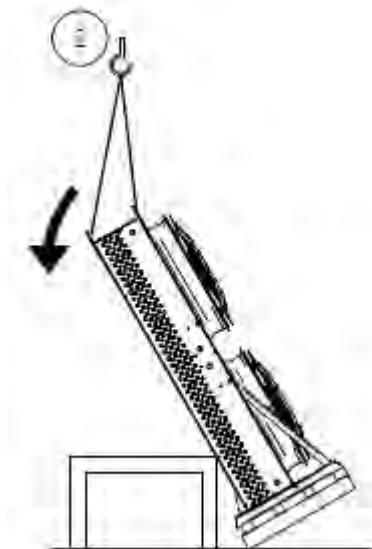

- ⇒ 2. For easier attachment of the legs, place the unit on a level base to prevent damage to the fins. The height of the base must be at least equal to the length of the legs.

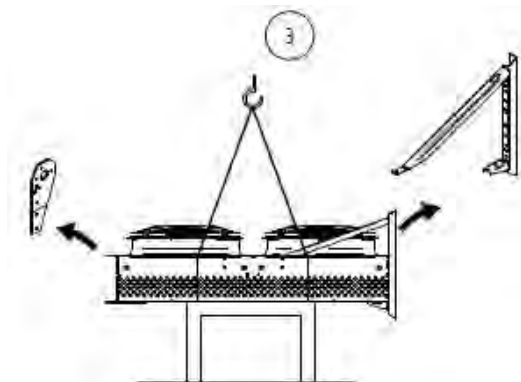

- ⇒ 3. Remove the transport bracket from the unit.

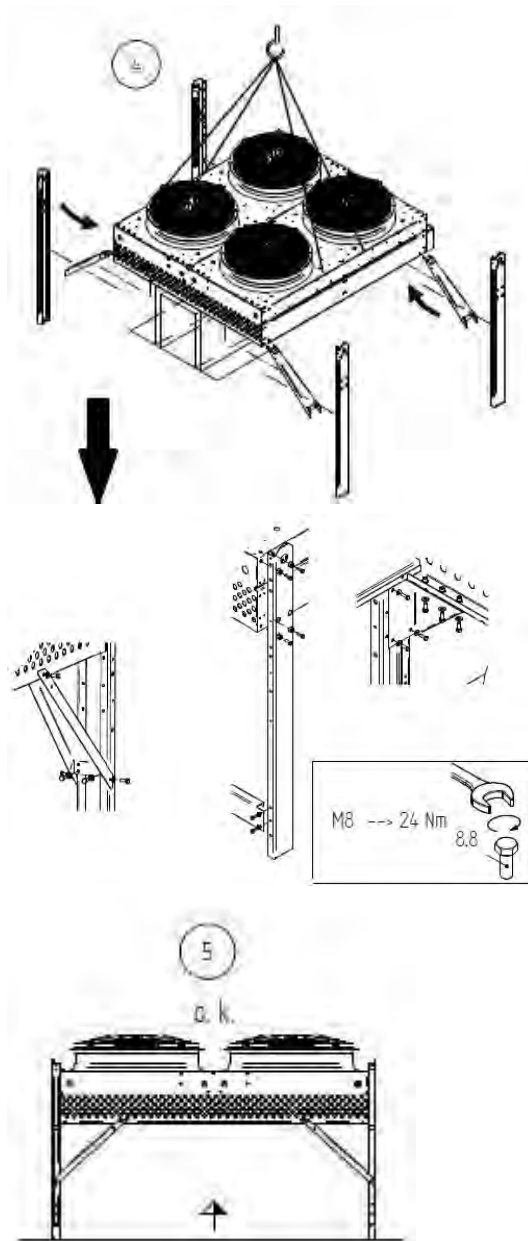

⇒ 4. Position the legs on the unit where they are to be screwed in place.

⇒ Bolt the brackets and legs to the unit as specified.

⇒ 5. Double-check all bolted connections. Mount the optionally supplied vibration dampers (if any).

5.3.2 Mounting the vibration dampers (accessories)

The optional vibration dampers are supplied loose with the unit.



M8 --> 25Nm
 M12 --> 80Nm
 M16 --> 206Nm
 M20 --> 415Nm



⇒ On delivery, check that the scope of delivery is complete.

⇒ Observe the torque specifications.

⇒ Assemble the individual parts in the order shown.

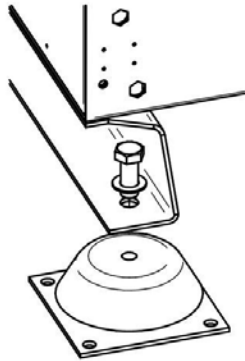

Mounted vibration damper

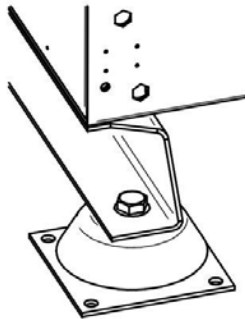

5.3.3 Mounting the unit

Required staff

- At least 2 persons are required for mounting.

Auxiliary equipment/tools

- Lifting accessories and lifting gear
- Cables
- Climbing aids
- Fasteners (fixing bolts/nuts, washers and rawlplugs)
- Master gauge for holes (see section "Designs")
- Writing materials and instruments for measuring lengths and angles
- Drilling tool
- Wall plugs
- Spanner or appropriate assembly tools for screws and nuts

Provisions for fixing

- Prevent mechanical stress on the unit as follows:
 - Ensure that all fixing points are at the same distance from the fixing level and that this distance is maintained permanently even under load.
- At the place of installation, bolt the unit into place at the fixing points using fixing bolts with washers. The fixing points must support the weight of the respective unit. The operator or installer of the equipment is responsible for ensuring that the bolted connections are of an adequate strength.
- Observe the following instructions when fixing the unit:

- The diameters of the mounting holes have been statically determined by the manufacturer; use suitable fixing bolts and washers. When calculating the bearing strength, it is imperative to take into account the total weight of the unit (= structural weight of the unit + weight of tube volume + additional weight such as moisture, ice, snow, dirt or similar).
- Secure fixing bolts against loosening by means of appropriate locking devices.
- The fixing bolts must not be overtightened.
- All fixing bolts must be tightened equally.
- Fix the unit in position and secure it against moving.
- Use the fixing points provided to fix the unit.

Anchoring of units for rooftop installations

General:

The load on the cable depends on the size of the unit, the building height (dynamic pressure) and the number of cables.

The specified values refer to an average unit (approx. 2.5 m high, 3 m wide) and a building height of up to 20 m above ground.

The unit must be anchored with at least two cables on the opposite sides (specifically, the sides with the longest edges).

The anchoring must be carried out in such a way that the standard fittings/legs for floor mounting (e.g. vibration dampers) do not exceed their max. permissible load.

The anchoring angle must not exceed 55°.

If there are significant changes to the static anchoring system, the forces will have to be recalculated.

Static system:

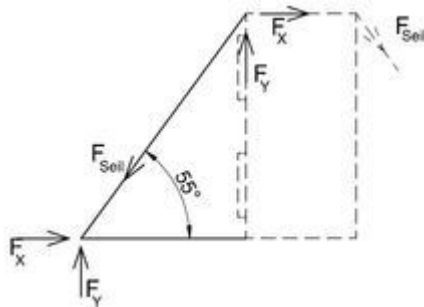

Tensile force in the cable:	$F_{Seil} = 3.5 \text{ kN}$
Resultant forces:	$F_x = 2.1 \text{ kN}$
	$F_y = 2.9 \text{ kN}$

The anchoring cable must be suitable for the maximum tensile force F_{Seil} and an additional cable pre-tension force.

The fixing of the anchoring cables at the place of installation depends on the local conditions.

For concrete, depending on the concrete quality, it is possible to use suitable anchors (e.g. supplied by Fischer, Hilti, Upat, etc.) with official technical approval. The fasteners must be suitable for the forces to be absorbed.

In the case of roof installations, ensure that the weather resistance of the roof is not impaired.

The forces present in the static system must be verified individually for each location.

5.4 Connecting the unit

5.4.1 Connecting the unit to the plant

Safety

⚠ WARNING	
	<p>RISK OF PERSONAL INJURY AND DAMAGE TO PROPERTY! Improper connection to the system will result in leaks that will lead to the escape of working fluid and corresponding risks (see section "Hazard due to working fluids").</p> <ul style="list-style-type: none"> • Follow the instructions for connecting the unit and pipes. • Refrigerant detectors and alarm systems to warn of the risk of explosion and fire, concentrations hazardous to health (e.g. with NH₃ and HFC) and for control purposes must be installed at the place of installation of the unit in acc. with EN 378-3.
ATTENTION	
<p>RISK OF DAMAGE TO PROPERTY DUE TO IMPROPER VENTILATION! Without proper ventilation, the unit can be damaged or destroyed by freezing liquid (in the case of water/glycol).</p>	
NOTICE	
<p>The owner or operator of the plant is responsible for water quality, flushing the system and implementing long-term protective and treatment measures. Damage resulting from failure to comply with these measures is not covered by the warranty.</p>	
NOTICE	
<p>Observe all safety instructions on the installation and commissioning (see section "Safety instructions for installation and commissioning").</p>	

Important notes on connecting the unit

- Regarding welding work: Observe the safety instructions on connecting the welding return line (see "Safety instructions for installation and commissioning").
- Perform soldering and welding work only on unpressurised units .
- Ensure that mechanical stresses and vibrations from the system are not transferred to the unit.
- Ensure that relief devices against liquid expansion are in place.
- With condensers and gas coolers/condensers: Ensure that the (subcooled) liquid can drain freely into the liquid receiver.
- It is imperative that working fluid connections are installed without tension and protected against linear thermal expansion and vibrations using horseshoe expansion joints or pipe compensators.
- Support the on-site piping with at least two fixed points before connecting to the unit.
- With the water/glycol working fluid: In addition, use a wrench/spanner to counterhold when connecting and disconnecting the threaded connections of pressurised pipes and components to prevent leaks.
- With the water/glycol working fluid: Use water of drinking water quality.

Important notes on preventing damage to the cooling circuit with water/glycol as working fluid

Prior to commissioning the cooling circuit, the person responsible for the plant must perform the following tasks:

- Removal of particulate foreign material from the circulating water by flushing the entire system.
Such foreign material in the circulating water may include, for example:
 - Corrosion products
 - Dirt
 - Micro-organisms
 - Welding residues
 - Materials that were introduced during tool changes
 - Detached biofilm
- Installation of a permanent protection device to prevent dirt accumulation and corrosion (e.g. dirt trap/filter).
- Use of corrosion inhibitors when using water as the working fluid.
- Analysis of water quality and, based on this, implementation of appropriate water treatment and conditioning measures.

Installation notes on pipes

- Keep the installation of pipes as short as possible; use as few bends as possible, and only those with large radii, to minimise the pressure drop.
- External loads must not act on the pipes and unit connections.
- Lay pipes (liquid and discharge lines, supply and return lines) separately from each other and insulate on both sides.
- Ensure that pipes are secured against vibrations, mechanical stresses and force transmission due to linear expansion.
- The free space around the unit must be sufficiently large to allow for the following measures:
 - Regular maintenance of the components,
 - Checking of components, pipes and fittings,
 - Repairs.
- It must be possible to shut off the unit in the event of leakage.

Procedure

- ⇒ Install the pipes in acc. with EN 378-1 and EN 378-3. Please note:
 - With condensers/gas coolers: Ensure that the (subcooled) liquid can drain freely into the liquid receiver.
 - With water/glycol: Ensure that the unit is well ventilated: The venting mechanism must be installed and protected against freezing. To this end, we recommended to fit the bleed valves and bleed connections with heat tracing and to insulate them.

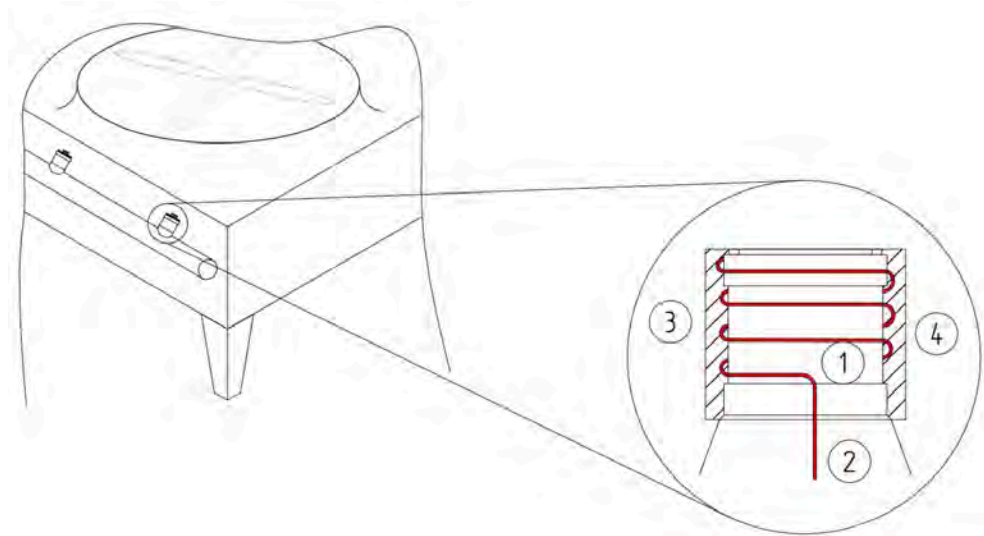

- (1) Automatic bleed valve
 - (2) Bleed connection
 - (3) Heat tracing
 - (4) Insulation
- With water/glycol: After completion of the pipe installation and before connecting the units, carry out professional internal cleaning, pressure test and evacuation in acc. with the guidelines of EN 378-2.
 - Ensure that relief devices against liquid expansion (in the case of water/glycol) are in place.
 - When using ammonia-soluble lubricating oils for refrigerating compressors in the refrigerating plant, special treatment is required, possibly necessitating the installation of dryers (ammonia-soluble lubricating oils for refrigerating compressors have an even greater affinity for water than NH₃ itself).
- ⇒ With stainless steel, the connection to the system must be welded.
 - ⇒ With copper, the connection to the system must be brazed.
 - ⇒ With units with threaded connections/flanges, bolt the connections together.
 - ⇒ In the case of threaded connections, prevent the pipe from twisting by holding it in place.
 - ⇒ When brazing, observe the following:
 - Braze all connections!
 - Caution! With TS < -40 °C, use silver solder! Ask the manufacturer for brazing specifications if necessary!
 - Avoid end-to-end joints; use copper pipe ends expanded on one side (capillary brazing)!
 - Avoid leaks, braze conscientiously and carefully!
 - Avoid overheating when brazing (risk of excessive scaling)!
 - Use shielding gas when brazing (to avoid scaling)!
 - ⇒ When welding, observe the following:
 - Avoid leaks, weld conscientiously and carefully.
 - Prevent overheating when welding (risk of excessive scaling).
 - Use shielding gas when welding (to prevent scaling).

5.5 Electrically connecting and protecting the unit

Introduction

Each unit is designed for a specific fan speed in acc. with the data sheet and wired accordingly. Some fans provide the option of a second, reduced speed or a continuous control as a

standard. For details, refer to the corresponding connection diagram. Changing the fan speed can have a negative impact on the thermodynamic configuration of the unit.

Interfaces

As interfaces to the electrical equipment, there are terminal boxes and switch cabinets for the electrical supply and signal exchange (see connection diagrams and manuals of the control systems).

Procedure

- ⇒ Connect the unit to the power supply in acc. with the connection diagram.
- ⇒ Use the prepared thermocontacts to protect the motors to safeguard any warranty claims.
- ⇒ Perform all electrical lines in acc. with the connection diagram, taking into consideration the EN 60204-1 and national regulations respectively.

5.6 Connection diagrams

Connection diagram for fan motor



See inside the motor terminal box at the fan or in the terminal box of the unit
See order documents

Connection diagram 0-10 V control

See inside the unit's terminal box
See order documents

5.7 Performing an acceptance test

Specific hazards

 WARNING	
	<p>RISK OF PERSONAL INJURY AND DAMAGE TO PROPERTY! Escaping working fluid can cause personal injury (see safety instructions regarding working fluids in section "Basic safety instructions").</p> <ul style="list-style-type: none">• Have the following acceptance test performed by a competent person before commissioning the unit, after making important changes to the unit and after replacing the unit.

Requirements

- The acceptance test must be performed by the manufacturer of the system!
- The temperature and humidity at the place of installation correspond to the permissible operating range (see section "Technical data of the unit").

When to perform an acceptance test

- Before commissioning the unit
- After making important changes to the unit
- After replacing the unit

Procedure

- ⇒ When operated with water, the unit must be put into operation quickly after initial filling (maximum two weeks) to prevent pitting corrosion caused by stagnant water.
- ⇒ Ensure that sufficient air can be sucked in and blown out.
- ⇒ Ensure the power supply is sufficiently dimensioned: Compare the connection diagram of the unit with the connection diagrams of the complete system.
- ⇒ Ensure that a professional equipotential bonding has been performed.
- ⇒ Check the unit for vibrations and movements that could be caused by the operation of the fans or the plant. Eliminate vibrations and external forces, following consultation with the manufacturer if required.
- ⇒ Perform a visual inspection of the structural design, the brackets and fastenings (materials, connections), the operability and the arrangement of the fittings.
- ⇒ Check all threaded connections on the fans and tighten them if necessary in acc. with the following table.

Screw/bolt	Type of bolt	Tightening torque
M6 (property class 8.8)	Cage nut/snap nut	10 Nm
M8 (property class 8.8)	Cage nut	23 Nm
M8 (property class 8.8)	Nut (steel)	27 Nm
M8 (property class 10.9)	Nut (steel, condenser and evaporator from Ø 710)	35 Nm

- ⇒ Check all other threaded connections and tighten if necessary.
- ⇒ Check the pipe connections.
- ⇒ Check that working fluid-carrying pipes are laid correctly.
- ⇒ Ensure that the unit is protected against mechanical damage.
- ⇒ Ensure the unit is protected against excessive heating up and cooling down.
- ⇒ Check the protection guards for damage.
- ⇒ Ensure that the unit can be inspected at any time and is always freely accessible:
 - Is the unit positioned so that it can be monitored and checked from all sides at all times?
 - Is sufficient space available for maintenance?
 - Are all working fluid-carrying components, connections and pipes and all electrical connections and lines easy to access?
 - Are the pipe identifications easily visible?
- ⇒ Check heat exchanger surfaces for dirt and clean if necessary (see section "Cleaning the coil").
- ⇒ Perform a function test on the fans (rotation direction, power consumption).
- ⇒ Check the wiring of the fans for damage.
- ⇒ Check the quality and execution of all connections (soldered connections, electrical connections and fixing connections).
- ⇒ Be sure to perform a pressure test in acc. with EN 378-2.
- ⇒ Perform a system test in acc. with the locally applicable regulations, e.g. EN 378-2 for the European region.

- ⇒ Check the corrosion protection: Perform a visual inspection of all pipes, components and component holders that are not heat-insulated. Document and archive the test results.
- ⇒ Perform a test run. Observe and check the unit during the test run, in particular for:
 - Quiet running of the fans (bearing noises, contact noises, imbalances, among other things)
 - Current consumption of the fans
 - Leaks

Procedure in case of defects

- ⇒ Report all defects to the manufacturer immediately.
- ⇒ Rectify the defects only upon consultation with the manufacturer.

Check after 48 operating hours

- ⇒ Check the unit and the unit's interaction with the system (cooling equipment and refrigeration system) again after approx. 48 operating hours, especially at the connections and at the fans.
- ⇒ Document the test result.

6 Operation

6.1 Safety instructions for operation

Please note

NOTICE
Observe the basic safety instructions (see section "Basic safety instructions").

Specific hazards

⚠ WARNING	
	<p>RISK OF PERSONAL INJURY AND DAMAGE TO PROPERTY! Escaping working fluid can cause personal injury (see section "Hazard due to working fluids").</p> <ul style="list-style-type: none"> Put the unit into operation only if all requirements are met (see section "Putting the unit into operation"). Ensure that the maximum operating pressure is never exceeded (also after shutdown)!

ATTENTION	
<p>DAMAGE TO PROPERTY CAUSED BY VIBRATIONS! The vibrations caused by the unit make a building vibrate which, in turn, results in collapse of this building or in errors of other systems.</p> <ul style="list-style-type: none"> In order to prevent overload during transport and resulting damage of the vibration dampers, the vibration dampers are supplied loose and can be mounted by the customer. Check the fans regularly and replace them if necessary (see section "Fans"). 	

NOTICE	
To prevent corrosion caused by stagnant water, units with water as working fluid must be put into operation within two weeks after filling.	

6.2 Putting the unit into operation

Requirements

Put the unit into operation only if the following requirements are met:

- A thorough and complete initial cleaning has been performed to remove dirt caused by transport and installation.
- Safe filling is ensured.
- The unit has been properly installed and connected (see section "Installation of the unit").
- A full acceptance test has been performed (see section "Performing an acceptance test").
- The operational readiness has been checked, and the operating point has been set (see below).
- All prescribed safety measures have been taken.

Checking the operational readiness

- ⇒ Ensure that all electrical protective measures are operational.
- ⇒ Ensure that all working fluid-side connections are securely established.
- ⇒ Ensure that all electrical connections (fans) are securely established.
- ⇒ Ensure that the protection guards are attached to the fans.
- ⇒ Ensure that all threaded connections on the fans, the fixing bolts on the unit and all other threaded connections are tight.

Setting the operating point

- ⇒ For the parameters for setting the operating point, refer to the order documents.
- ⇒ Ensure that the specified operating point is maintained. For this, secure the operating elements for setting the operating point against access by unauthorised persons (e.g. by sealing, screwing on caps, removing the handwheels).

Procedure

- ⇒ Switch on the system including the electrical system (see the system's operating instructions).
- ⇒ Switch on the unit.
- ⇒ Open the valves on the inlet and outlet side of the system.
- ⇒ Activate the fans.
- ⇒ Wait until the operating point is reached. Once the operating point is reached, the unit is ready to operate (see the system's operating instructions).
- ⇒ Check units with heat carrier regularly for correct bleeding after starting the pump.

6.3 Taking the unit out of operation

Introduction

The units are components of a system, including the heat exchanger circuit. The unit is taken out of operation by switching off the system in accordance with the system's operating instructions.

NOTICE

When shutting down the unit, observe the max. operating pressure! When required, take precautions to ensure that it cannot be exceeded.

Procedure

- ⇒ Switch off the fans
- ⇒ Switch off the working fluid feed pump (if any)
- ⇒ Switch off the electrical installation

6.4 Shutting down the unit

Safety

NOTICE

All refrigerants must be removed from the unit by suction and disposed of by an approved specialist company in the field of refrigeration.

Procedure

- ⇒ Shut the unit down (see above).
- ⇒ Secure the unit as follows:
 - Secure the fan motor drives against restart.
 - Secure the working fluid-carrying pipes against supply with working fluid.
 - Protect against damaging effects at the place of installation or intermediate storage location so that the unit's components are kept in good condition and the intended use and usability of the unit are maintained. To this end, appropriate storage conditions (see section "Storing the unit prior to installation") must be provided, precautionary corrosion protection measures must be taken, regular checks of the functionality of the fans must be performed and the shutdown unit must be checked regularly.
- ⇒ With refrigerants (FC/HFC, NH₃, CO₂, and refrigerants of classes A2L to A3) prior to disassembly/removal: Completely remove the working fluid from the unit by suction into a suitable refrigerant container, and completely drain the lubricating oil for refrigerating compressors if necessary.
- ⇒ With coolants prior to disassembly/removal: Completely drain the working fluid from the unit.

If the system is shut down for a period of three weeks or longer, the following must be observed:

- ⇒ Completely disconnect the unit and indicate this accordingly.
- ⇒ Remove dirt and deposits from the outside and inside of the unit.
- ⇒ Store the unit in a place that is not exposed to sunlight. It is recommended to cover the air outlets of the fans to prevent dirt and deposits from entering.

NOTICE

Operate the fans for approx. 2 – 4 hours per month during idle times of one month or longer in order to maintain functionality.

6.5 Putting the unit back into operation after shutdown

Introduction

The unit must be put back into operation in acc. with the system-specific design as set out in the system's operating instructions.

Procedure

- ⇒ Test the unit's readiness for operation.
- ⇒ Perform a pressure test in acc. with EN 378-2 and a visual inspection for corrosion protection.
- ⇒ Put the unit into operation (see section "Putting the unit into operation").

ATTENTION

Water residues in a refrigerating plant operated with refrigerants can result in damage to property!

- Evacuate to ensure that a sufficient degree of dryness of the refrigeration circuit is achieved in acc. with the requirements of EN 378.

6.6 Changeover to a different working fluid

Specific hazards

WARNING**RISK OF PERSONAL INJURY AND DAMAGE TO PROPERTY!**

Operating the unit with a different working fluid without the prior consent of the manufacturer can result in significant dangers (see section "Hazard due to working fluids").

- The unit must not be changed over to a different working fluid without prior written consent from the manufacturer.

Requirements for the working fluid

- Ensure that the unit manufacturer has agreed to the changeover.
- Ensure that the unit is filled with the correct working fluid.
- Ensure that all materials used in the unit are compatible with the new working fluid.
- Ensure that the permissible pressure is not exceeded.
- Check that the new working fluid can be used without requiring a new test certificate for the unit.
- Ensure that classification is complied with.
- Reset the safety device for the unit or replace it where necessary.
- Prevent mixtures with residues of working fluid and possibly oil.
- Change all information regarding the new working fluid accordingly.
- Change the complete documentation including these instructions and the system's operating instructions accordingly.

Procedure

- ⇒ Change the working fluid following written consent by Güntner GmbH & Co. KG and in compliance with the requirements for the working fluid.
- ⇒ Perform an acceptance test (see section "Performing an acceptance test").

6.7 Troubleshooting

Safety instructions

NOTICE

Observe all basic safety instructions and the safety instructions for operating the unit (see sections "Basic safety instructions" and "Safety instructions for operation").

Use suitable tools, protective clothing and safety devices.

Hotline

Phone +49 8141 242-190

E-mail: claims@guentner.com

Troubleshooting table

The following table shows possible faults and the measures to correct them.

Fault	Possible cause(s)	Remedy
Fan motor not running	Power supply interrupted	Restore power supply
	Fan blade stuck	Enable fan to rotate freely
Bearing noises	Defective fan motor	Replace the fan
Unit vibrating	Defective fan blades	Replace fan blades
	Fan bracket loose	Tighten the fixings and replace them if necessary
Unit capacity is not achieved	Coil is very dirty on the air side	Clean the coil
	Fans not running properly or fail to operate	Repair or replace fans
	Working fluid pressurising defective (temperature and quantity insufficient)	Set the working fluid pressurising values (temperature and quantity) according to the design data
	Wrong mixing ratio (with the working fluid water/glycol)	Adjust mixing ratio (concentration, inhibition)
Working fluid escaping	Working fluid-carrying components of the unit are leaking	Switch off the working fluid supply and the fans, document the damage, rectify the leak (see section "Fixing leaks")

Rectify faults

- ⇒ Close the main lines of the working fluid supply
- ⇒ Wear personal protective equipment (PPE)
- ⇒ Wear respiratory protection if necessary (e.g. with NH₃)
- ⇒ Determine and document the size of the leak
- ⇒ Shut off all working fluid supply lines
- ⇒ Sound the alarm at the slightest suspicion of injured persons in connection with working fluid. First get persons to safety, then eliminate leaks (see section "Fixing leaks").
- ⇒ Press the Emergency STOP switch. This switches off valves, motors and other components to prevent working fluid from escaping.
- ⇒ Close shut-off valves, especially on the liquid side, where possible section by section so that the working fluid volume in the leakage area is kept as low as possible.

- ⇒ If possible, siphon off or drain the system section concerned in a controlled manner, or move the working fluid to other parts of the system. Here too it must be ensured that no liquid working fluid is locked in by shutting off system sections.
- ⇒ If the escaped liquid working fluid (with NH_3) has formed a puddle underneath the unit, the heat supply to the liquid – and thus further vapour formation – must be reduced by covering the puddle with a film (e.g. PE) or synthetic medium expansion foam (fire brigade) so that there is enough time for disposal measures.



7 Maintenance and cleaning





7.1 Safety instructions for maintenance and cleaning

Please note

NOTICE
Observe the basic safety instructions (see section "Basic safety instructions").
NOTICE
Non-compliance with the maintenance schedule can result in cracks and breakage in the pipes and leakage of the working fluid.
NOTICE
The operator is responsible for providing protective clothing for maintenance and cleaning.
NOTICE
The operator is responsible for selecting suitable cleaning agents, antifreeze agents und corrosion inhibitors, and for observing and complying with the manufacturers' instructions.

Specific hazards

⚠ DANGER	
	<p>ELECTRICAL VOLTAGE! Cleaning using a jet of water or steam causes water to enter live components. This results in a short circuit at the electrical connections and/or a life-threatening electric shock. This, in turn, can cause severe injury or even death of bystanders.</p> <ul style="list-style-type: none"> • Completely disconnect the supply line before performing electrical work on the unit. • Do not point the water jet at live components (e.g. terminal box). • Do not use steam cleaners or high-pressure cleaners on live components. • Ensure that live components are not hit by water or vapour jets (cover if necessary). • Observe the cleaning pressures and distances when cleaning. • Work on the unit and the connection and control configuration must be performed by specialist staff. • Check electrical components regularly. • Perform earthing checks and visual inspections of the earthing points regularly. • Connect the unit to the building's earthing system in the proper manner. • Provide adequate lightning protection.
	

⚠ WARNING		
	<p>RISK OF CRUSHING! When working in the vicinity of moving components, limbs can get caught between the components and be crushed.</p> <ul style="list-style-type: none"> • Completely disconnect the unit before performing maintenance work. • Secure the unit against unintentional restart. A lockable repair switch is available or to be provided by customer. Attach an appropriate warning label to the unit. • Wear personal protective equipment (PPE). 	
⚠ WARNING		
	<p>RISK OF FALLING! When replacing the fan, there is a risk that the operator or another person standing or walking on the unit surface falls into the open area of the fan and injures him or herself.</p> <ul style="list-style-type: none"> • During maintenance on the open fan, uninvolved persons are not allowed in the danger zone. • Ensure that, during maintenance, the open area of the fan is clearly marked and secured to prevent accidental entry. 	
⚠ CAUTION		
	<p>RISK OF DAMAGE TO THE EYES! During cleaning work, there is a risk of injury from the water or air jet, dust or chemical cleaning agents.</p> <ul style="list-style-type: none"> • Wear safety goggles! 	

7.2 Procedure prior to all maintenance work

Before performing any maintenance work, carry out the following safety measures:

- ⇒ Completely disconnect the unit and secure it against accidental switching on.
- ⇒ Drain or siphon off the coil (heat exchanger) of the unit.
- ⇒ Completely remove the working fluid from the leaky unit, especially prior to soldering and welding work.
- ⇒ Clean and blow out the coil (heat exchanger) of the unit.

7.3 Inspection/maintenance schedule

7.3.1 Unit

Measure	Means	Interval
Remove frost and perform partial cleaning	Mechanical	As required (visual inspection)
Perform complete cleaning	Warm water or environmentally safe cleaning agent that is compatible with the unit's materials	As required (visual inspection)
Testing in acc. with PED as prescribed by the accredited inspection bodies		Every 12 months
Inspection of the system (leak tightness tests, among other things) in acc. with DIN EN 378-4		Every 12 months
Check for leaks		Every 6 months
Check corrosion protection		Every 6 months
Check frost protection		Every 6 months
Check earthing concept		Every 6 months (visual inspection) Every 12 months (measurement)
Check that electrical connections, cables and components are not damaged (visual inspection)		Every 6 months
Check fastenings: Check all fasteners of the unit including any optional additions	Mechanical	Every 6 months
Check fixings and load-bearing elements (e.g. crane lug bolts) for corrosion and load-bearing capacity or structural integrity; replace them if necessary	Mechanical	Every 12 months
Check units with water/glycol working fluid for correct bleeding. Note: During the test, the pump must be running.		Every 6 months
For terminal boxes, check cable entries and their seals for damage and replace if necessary.		Every 6 months

7.3.2 Heat exchanger coil

External inspection

Have a competent person (recommendation: Güntner GmbH & Co. KG) perform a regular external check (visual inspection) on the unit every 5 years.

Maintenance schedule

d = daily, w = weekly, m = monthly, y = yearly				
Work to be performed	d	w	m	y
Check the coil for dirt accumulation. • In the event of dirt accumulation: Clean the coil (see section "Cleaning the coil").	X			
Check the coil's general condition. • If damage is found: Rectify damage.		X		
Check the coil's operating point (see section "Installation and commissioning"). • If change in fan capacity is found: Restore required system-side conditions. • If change in surface temperatures is found: Restore required system-side conditions.			X	
Check the coil and connections for leak tightness. • Repair unit sections affected (see section "Fixing leaks")				X*
Check the working fluid pressurising of the coil. • Restore required system-side conditions.				X*
Check the coil for corrosion. • Corrosion or damage on core tubes, fins, support structures, pipe connections, fastenings: Repair unit sections affected.				X*

*) Recommended: every six months

7.3.3 Fans

Maintenance schedule

d = daily, w = weekly, m = monthly, y = yearly				
Work to be performed	d	w	m	y
Check fans for dirt accumulation • In the event of dirt accumulation: Clean the fans (see section "Cleaning the fans")	X			
Check the fan drive for quiet running • Vibrations on the unit: Eliminate imbalances • When required, tighten blade fixing devices and correct blade settings		X		
Check fan bearings (every six months by manually turning the rotor while the fan is switched off) • Running noise and smoothness of running changes: Replace the fan			X	
Impeller: Corrosion on bolts (with threaded blades)				X*

7.4.3 Cleaning the coil

Introduction

Removing the fans (see section "Dismantling and disposal") creates space with a few simple turns for better cleaning of the heat exchanger coil. The cleaning method depends on the type and degree of soiling and the place of installation. With loose and dry dirt, cleaning with compressed air is sufficient. With solid, damp and greasy dirt, we recommend hydraulic cleaning.

Specific hazards

⚠ CAUTION	
	<p>RISK OF DAMAGE TO PROPERTY!</p> <p>If the pressure is too high, the distance is too small or the cleaning jet hits the fins at an angle, the fins can be damaged. Mechanical cleaning with hard objects (e.g. steel brushes, screwdrivers, etc.) will damage the heat exchanger.</p> <ul style="list-style-type: none">• Use a pressure of max. 30 bar for hydraulic cleaning and max. 8 bar for cleaning with compressed air!• Keep a minimum distance of 200 mm from the fins!• Always direct the jet at right angles to the fins (max. deviation of ± 5 degrees) to prevent the fins from bending!• Do not use hard objects for cleaning!

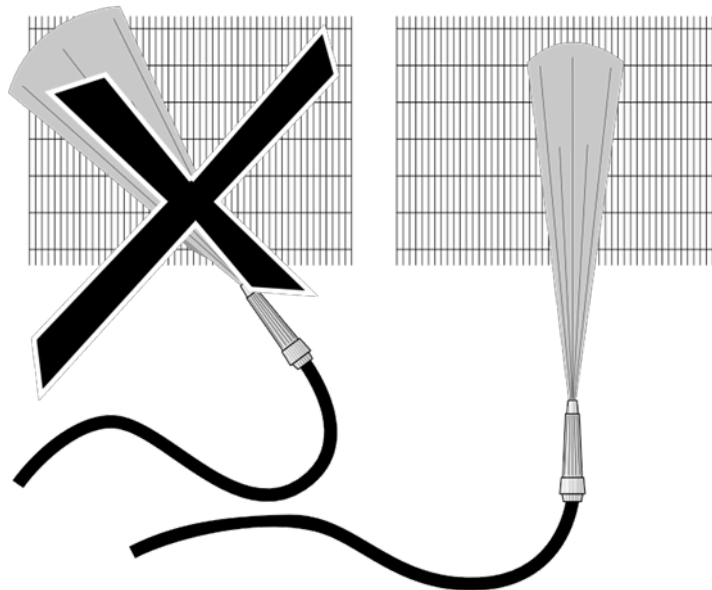

Preparation for cleaning

- ⇒ Prepare and shut off the unit in acc. with the system's operating instructions
- ⇒ Clean the coil (heat exchanger) with one of the following procedures:
 - Cleaning with compressed air (see section "Cleaning with compressed air")
 - Hydraulic cleaning (see section "Hydraulic cleaning")
 - Cleaning with brush or brush and compressed air (see section "Cleaning with brush or brush and compressed air")

7.4.3.1 Cleaning with compressed air

Procedure

- ⇒ Blast the coil with compressed air (max. 80 bar pressure, distance to the fins at least 200 mm; against the air flow direction) to remove dirt and impurities. Please note:
 - Preferably clean from inside to outside and from top to bottom to prevent loosened dirt from settling on areas that have already been cleaned.
- ⇒ Clean until all dirt has been removed.

7.4.3.2 Hydraulic cleaning

Procedure

- ⇒ Always remove heavier damp or greasy dirt against the air flow direction, using a high-pressure water jet (max. 30 bar pressure) or a steam pressure jet (max. 30 bar pressure). In either case, use a flat spray nozzle (distance of at least 200 mm) and, if required, neutral cleaning agents. Always direct the jet at right angles to the fins (max. deviation of ± 5 degrees). Please note:
 - With oily and greasy deposits, add a cleaning agent to the water.
 - When applying cleaning agents, change them from time to time to prevent resistance development in germs.
 - When using chemical cleaning agents, ensure that they do not attack the surfaces of the unit. After cleaning, the unit must be rinsed with warm water so that it is free of cleaning agents.
 - Clean against the air flow direction and from top to bottom (Güntner recommendation) so that dirt is not pushed even deeper into the heat exchanger or does not move to already cleaned areas.
- ⇒ Clean until all dirt has been removed.

7.4.3.3 Cleaning with brush or brush and compressed air

Procedure

- ⇒ Remove dry dust or dirt with a brush, a hand brush and – depending on the situation – compressed air (max. 8 bar pressure, minimum distance of 200 mm to the fins; against the air flow direction) or with a powerful industrial vacuum cleaner. Please note:
 - Use soft brushes (no steel brushes or similar).
 - Preferably clean from inside to outside and from top to bottom to prevent loosened dirt from settling on areas that have already been cleaned.
- ⇒ Clean until all dirt has been removed.
- ⇒ Always brush in the longitudinal direction of the fins, never across.

7.4.4 Cleaning the fans

Procedure

- ⇒ Completely disconnect the unit and secure it against accidental switching on.
- ⇒ Remove protection guard and accessories (if any).
- ⇒ Clean the fans in acc. with one of the following procedures:

- Cleaning with compressed air: Blow the fans with compressed air (pressure max. 10 bar, distance to the fins at least 200 mm) to remove dirt and impurities. Clean until all dirt has been removed.
 - Cleaning with brush and compressed air: Remove dry dust or dirt with a brush or a hand brush, and then with compressed air (pressure max. 10 bar, distance to the fins at least 200 mm) or a powerful industrial vacuum cleaner. Clean until all dirt has been removed.
- ⇒ Switch on the unit.

7.5 Procedure after all maintenance work

After completing all maintenance work, carry out the following safety measures:

- ⇒ Ensure that the switching and activation devices, the measuring and display devices and the safety devices function properly.
- ⇒ Ensure that the working fluid fittings function properly.
- ⇒ Check the labelling of the pipes and ensure that the labels/tags are visible and legible.
- ⇒ Check the fastening and the corrosion protection of the components concerned.
- ⇒ Ensure that the electrical connections (e.g. fans) function properly.
- ⇒ Perform a pressure test in acc. with EN 378-2 and a leak test (see operating instructions of the plant).
- ⇒ Perform an acceptance test (see section "Performing an acceptance test").
- ⇒ Perform a functional test (see the system's operating instructions).
- ⇒ Document all tests performed and their results.

8 Dismantling and disposal

8.1 Safety instructions on dismantling and disposal

Please note

NOTICE
<p>Oberserve all basic safety instructions (see section "Basic safety instructions"), all safety instructions for transport (see section "Safety instructions for transport and unpacking"), all safety instructions for installation (see section "Safety instructions for installation and commissioning") and all safety instructions for maintenance (see section "Safety instructions for maintenance and cleaning")!</p>

Specific hazards

⚠ CAUTION	
	<p>RISK OF INJURY CAUSED BY CORROSION! The unit is exposed to corrosive environment for a long time. Due to the onset of corrosion, the unit loses stability and is no longer suitable for lifting by crane or industrial truck with forks and endangers bystanders.</p> <ul style="list-style-type: none"> • Check the fan unit in acc. with the maintenance schedule. • Check all fixing bolts and fixing devices, especially of the lifting accessories (e.g. crane lug bolts), load-bearing components, lifting elements, fixing elements and fans of the unit regularly and especially before and after lifting the unit for corrosion damage, lifting capacity and structural integrity, and replace them if necessary. In case of doubt, hire a specialised company. • Prior to dismantling and disposal of the unit, ensure that there are no loose or slack parts on the unit.

ATTENTION	
<p>RISK OF ENVIRONMENTAL DAMAGE! Recovering or disposing of working fluid can result in working fluid or refrigerator oil emissions being released into the environment, causing pollution.</p> <ul style="list-style-type: none"> • All working fluids must be removed from the unit by suction and disposed of by an approved specialist company in the field of refrigeration. • Ensure that no working fluid enters the groundwater. • Operate the facility for recovering or disposing of working fluids in such a way that the risk of working fluids being released into the environment is kept as low as possible. • Ensure that all applicable standards and guidelines are complied with. • Observe local regulations. 	

ATTENTION	
<p>RISK OF POLLUTION! If the materials are not disposed of correctly, this could result in environmental damage.</p> <ul style="list-style-type: none"> • Only dispose of materials in compliance with the waste disposal laws that are binding for the country of operation. 	

8.2 Dismantling the unit

Required staff

- Dismantling must be performed by at least two people (specialist staff).

Auxiliary equipment/tools

- Lifting accessories and lifting gear
- Climbing aids

Procedure

- ⇒ Completely disconnect all systems.
- ⇒ Shut down and drain the unit (see section "Shutting down the unit").
- ⇒ Make sure that there are no loose parts on the unit.
- ⇒ Follow the removal sequence:
 - Remove the protection guard (if any)
 - Remove the fan(s)
 - Remove the tray (if any)
- ⇒ Follow the installation steps in reverse order (siehe Abschnitt "Installation of the unit").

8.3 Disposing of the unit

Introduction

At the end of its life cycle, the unit requires proper and professional disposal of the materials and substances used.

Procedure

- ⇒ Disposal must be performed by competent persons.
- ⇒ All unit components, e.g. working fluids, lubricating oil for refrigerating compressors, coil (heat exchanger), fans and optional accessories must be disposed of properly.
- ⇒ Treat used working fluid that is not intended for reuse as waste and dispose of it safely. There must be no emissions into the environment.
- ⇒ Do not use a disposable single-use container as working fluid vapour residues in the container could escape during disposal.
- ⇒ Do not overfill the working fluid container. The maximum permissible pressure of the working fluid container must not be exceeded during the entire work process.
- ⇒ Do not pour the working fluid into a fluid container that contains a different or an unknown working fluid. Do not release this other or unknown working fluid into the atmosphere but rather identify it, reclaim it or properly dispose of as specified.
- ⇒ Instruct an officially authorised facility to destroy the working fluid.
- ⇒ All applicable laws, regulations, directives and standards must be complied with when disposing of materials and substances.